

SUZUKI

SERVICE MANUAL

MODEL

RV125

LEFT AND RIGHT SIDE VIEWS

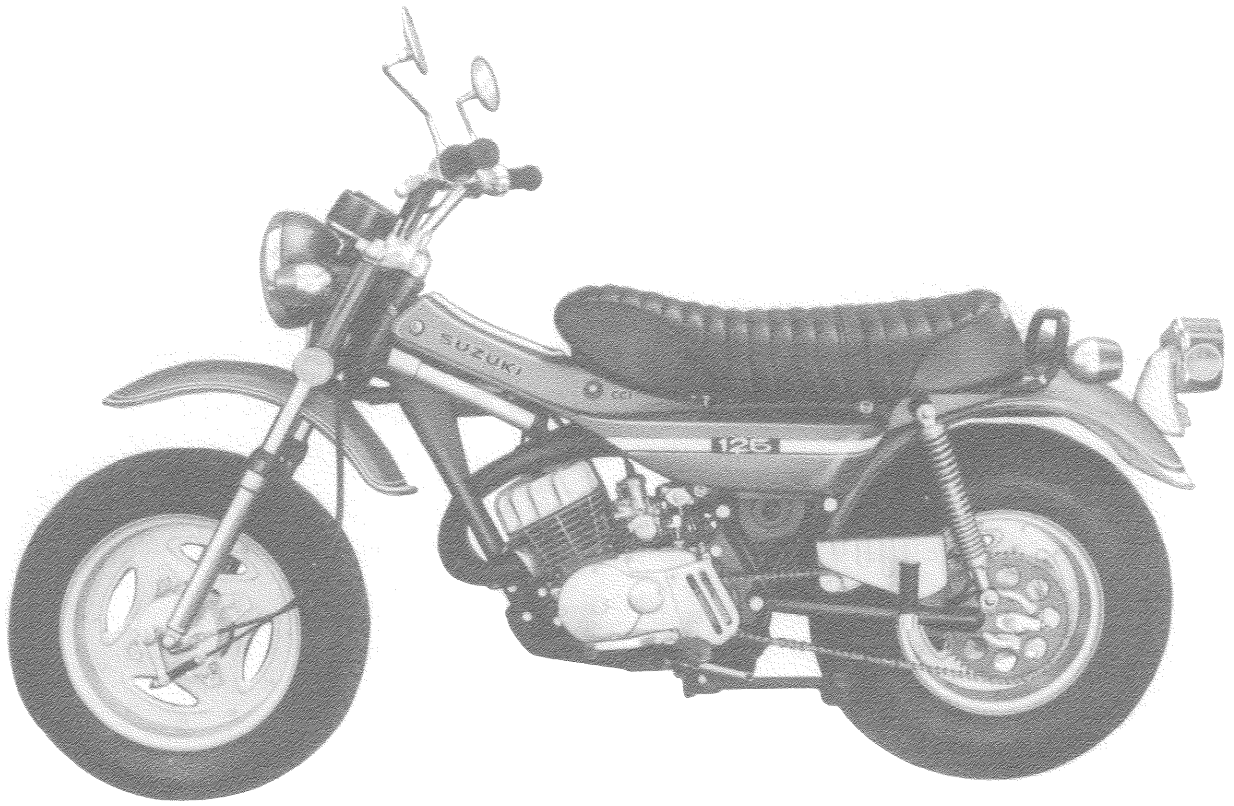

INTRODUCTION

This manual has been prepared to provide service operators with necessary information for the maintenance and the repairs of the motorcycle. The contents are made plain so that less-experienced mechanics may carry out the proper jobs according to the items of assembly and disassembly instructions. For fully qualified mechanics, the necessary service data for the inspections and repairs is provided in this manual. Since it is above all important on servicing a motorcycle to know thoroughly its construction and the necessary data, it is highly recommended for those who are engaged in servicing RV125 to study beforehand this manual notwithstanding their technical ability.

We trust the publication of this manual would be of assistance in the service activity as well as in the study of RV125.

SUZUKI MOTOR CO., LTD.

Export Service Section

CONTENTS

	Page
1. SPECIFICATIONS	1
2. PERFORMANCE CURVES	3
3. GENERAL INSTRUCTION	4
4. SPECIAL TOOLS	5
5. NECESSARY MATERIALS	7
6. TROUBLE SHOOTING	8
7. ENGINE	
7-1. REMOVAL	12
7-2. DISASSEMBLY AND ASSEMBLY	18
7-3. NECESSARY POINTS ON ASSEMBLY	28
7-4. ENGINE LUBRICATION SYSTEM	34
7-5. CARBURETOR	36
7-6. STARTER SYSTEM	38
7-7. CLUTCH	39
7-8. TRANSMISSION	41
7-9. AIR CLEANER	42
7-10. ENGINE ELECTRICAL	43
8. BODY	
8-1. FRONT FORK	48
8-2. REAR SHOCK ABSORBER	51
8-3. BRAKES	52
8-4. WHEELS	53
8-5. DRIVE CHAIN	56
8-6. BODY ELECTRICAL	57
9. SPECIFICATIONS FOR INSPECTION AND REPAIR	59
10. TIGHTENING TORQUE	62
11. IMPORTANT FUNCTIONAL PARTS	63

*PERIODICAL INSPECTION LIST

*WIRING DIAGRAM

*EXPLODED VIEW OF ENGINE

*REMOVABLE CHARTS

 Wiring diagram

 Exploded view of engine

1. SPECIFICATIONS

DIMENSIONS & WEIGHT

Overall length	77.2 in (1,960 mm)
Overall width	30.3 in (770 mm)
Overall height	39.6 in (1,005 mm)
Wheelbase	51.4 in (1,305 mm)
Road clearance	7.7 in (195 mm)
Tires, front	5.4-14, 4PR
rear	6.7-12, 4PR
Dry weight	244 lb (111 kg)

PERFORMANCE

Maximum speed	55-60 mph (88-96 kph)
---------------	-----------------------

ENGINE

Type	2 stroke, air-cooled, gasoline
Piston displacement	123 cc (7.5 cu in)
Bore x Stroke	56 x 50 mm (2.20 x 1.97 in)
Cylinders	Single, aluminium
Corrected compression ratio	6.3 : 1
Maximum horsepower	10 hp/6,000 rpm
Maximum torque	8.8 ft-lb (1.22 kg-m)/5,500 rpm
Starter	Primary kick

FUEL SYSTEM

Carburetor	VM22SH
Air cleaner	Wet polyurethane filter
Fuel tank capacity	1.2/1.0 US/Imp gal (4.7 ltr) including reserve 2.1/1.8 US/Imp pt (1 ltr)

LUBRICATION SYSTEM

Engine	Suzuki CCI
Gear box	550 cc (1.16/0.97 US/Imp pt)
Engine oil tank capacity	1.7/1.4 US/Imp pt (0.8 ltr)

IGNITION SYSTEM

Type	Flywheel magneto
Ignition timing	22° (2.41 mm in piston stroke) B.T.D.C.
Spark plug	NGK B-7HS or Nippon Denso W22FS

POWER TRANSMISSION

Clutch	Wet, multi-disc
Gear box	5-speed, constant mesh
Gear shifting	Left foot operated
Primary reduction ratio	3.562 (57/16)
Final reduction ratio	3.400 (51/15)
Gear ratios (Overall reduction ratios)	
1st	2.750 : 1 = 33/12 (33.30)
2nd	1.812 : 1 = 29/16 (21.95)
3rd	1.250 : 1 = 25/20 (15.14)
4th	1.000 : 1 = 23/23 (12.11)
5th	0.800 : 1 = 20/25 (9.69)
Drive chain, size	428D
number of links	116

SUSPENSION

Front suspension	Telescopic forks with hydraulic damper
Rear suspension	Swinging arm with hydraulic damper

STEERING

Steering angle	42° (right & left)
Castor	61°
Trail	3.78 in (96 mm)
Turning radius	6.6 ft (2 m)

BRAKES

Front brake	Right hand, internal expanding
Rear brake	Right foot, internal expanding

ELECTRICAL EQUIPMENT

Generator	Flywheel magneto
Battery	6V 4AH
Fuse	15A
Head lamp	6V 25/25W
Tail/Brake lamp	6V 3/21CP (3/10W)
Turn signal lamp	6V 8W x 4
Speedometer lamp	6V 3W
Tachometer lamp	6V 3W
Neutral indicator lamp	6V 3W
High beam indicator lamp	6V 1.7W
Turn signal indicator lamp	6V 1.7W

*The specifications subject to change without notice.

2. PERFORMANCE CURVES

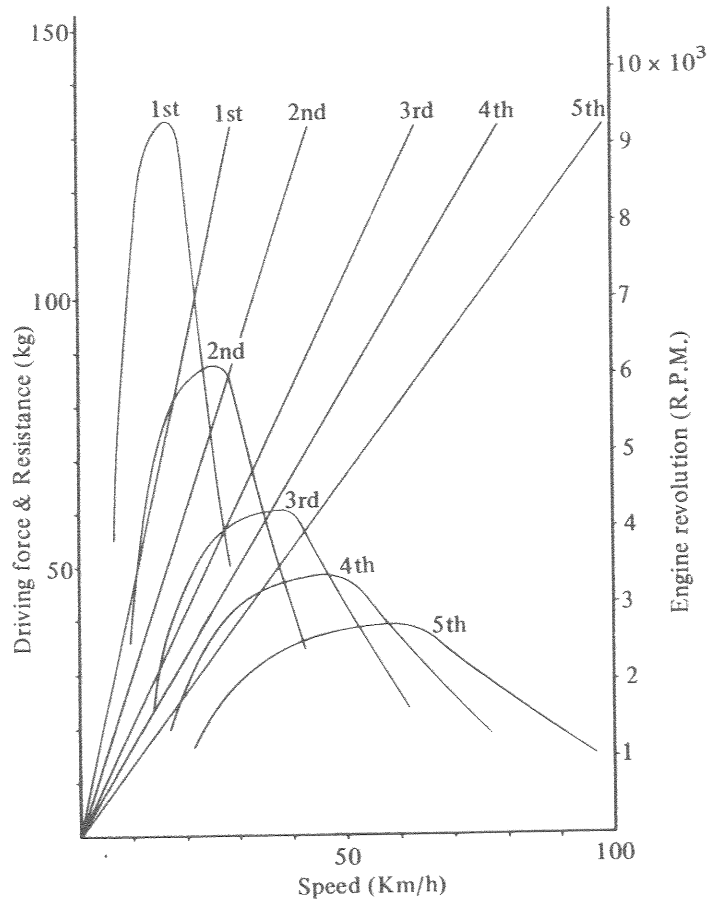
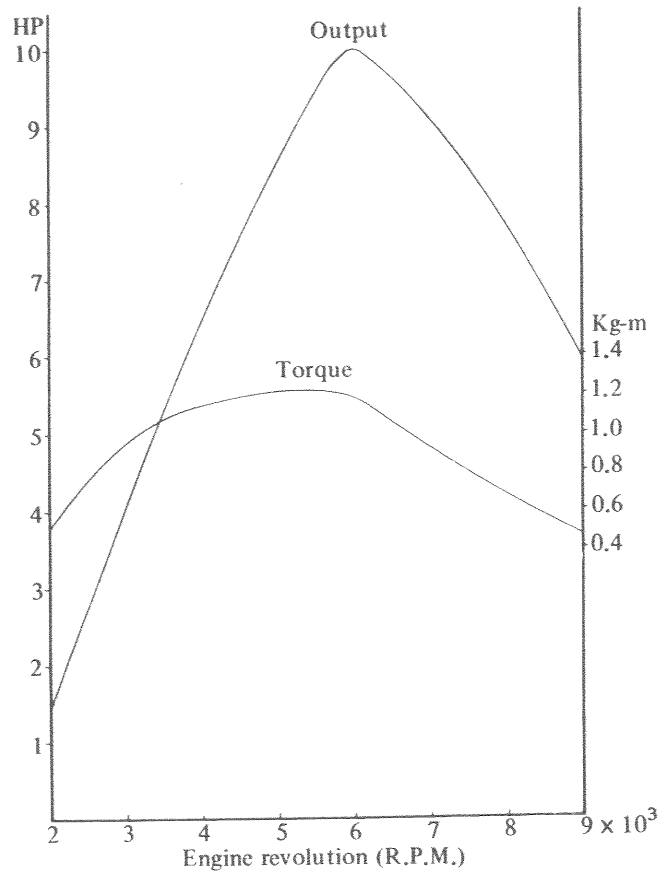

3. GENERAL INSTRUCTION

To keep the motorcycle in peak condition, advise your customers to follow these instructions and this will give top performance at all times.

3-1. BREAKING-IN

The life of the motorcycle depends on the breaking-in of the engine and the way in which the motorcycle is treated. Therefore, breaking-in with the best care is much important to prevent excessive wear of the parts and noise and to prolong the engine life. During the breaking-in period, do not operate the motorcycle at high speed nor allow the engine to run wide open. Keep to specified breaking-in engine speed limit. Gradually raise the speed as covered mileage increases.

First 500 miles (800 Km) below 4,500 rpm
Up to 1,000 miles (1,600 Km) below 5,500 rpm

3-2. FUEL AND OIL

The engine's moving parts such as crankshaft, crankshaft bearings, con-rod, piston and cylinder wall are lubricated by fresh oil pressure-delivered by Suzuki CCI system separately from the fuel supply. Put gasoline only in the fuel tank and engine oil in the oil tank.



FUEL GASOLINE OF 85-95 OCTANE
IN RESEARCH METHOD
ENGINE OIL . . . SUZUKI CCI OIL

* If Suzuki CCI oil is not available, non-diluent (non-self mixing type) two stroke oil with around SAE No. 30 may be used instead.

TRANSMISSION OIL SUZUKI TRANSMISSION OIL, 550cc (1.16/0.97 US/Imp pt)
CHANGE FIRST 750 MILES (1,000 KM) AND 2,000 MILES
(3,000 KM) THEREAFTER.

* If Suzuki transmission oil is not available, a good quality 20W/40 multi-grade motor oil may be used instead.

3-3. GENUINE PARTS

When replacing parts, always use Suzuki genuine parts, which are precision-made under severe quality control. If imitation parts (not genuine parts) are used, good performance cannot be expected from the motorcycle and in the worst case, they may cause a breakdown.

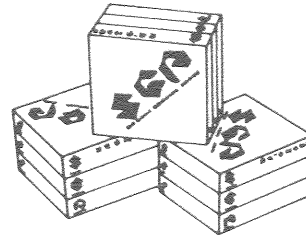

3-4. PERIODICAL INSPECTION

To prolong the life of the motorcycle and avoid unforeseen occurrence of serious troubles, the periodical inspection is indispensable. Be sure to check the motorcycle periodically according to the list given at the end of this manual.

4. SPECIAL TOOLS

Special tools listed below are used to disassemble, assemble and to perform maintenance and service. These special tools make works easy which can not be done simply with ordinary tools and prevent the parts from damage. It is recommended to provide these special tools as shop equipment.

Ref. No.	Part Number of Tool	Use for
1	09910-20113	Locking crankshaft
2	09910-92810	Separating crankcase
3	09910-32811	Assembling crankcase
4	09930-10111	Removing or installing spark plug
5	09910-10710	Installing 8 mm stud bolt
6	09930-30113	Removing flywheel rotor
7	09930-40113	Locking flywheel rotor and engine sprocket
8	09930-20111	Adjusting contact point gap
9	09920-52810	Locking clutch sleeve hub
10	09920-60310	Locking clutch sleeve hub
11	09920-20310	Removing or installing clutch spring pin
12	09913-70122	Installing bearing and oil seal
13	09913-80111	Installing bearing and oil seal
14	09913-50110	Removing oil seal
15	09920-70111	Removing snap ring
16	09920-70120	Removing snap ring
17	09900-09002	Tightening or loosening cross-head screw
18	09910-70110	Removing carbon
19	09940-10122	Loosening or tightening steering stem nut
20	09941-00110	Loosening or tightening fork outer tube nut
21	09931-00112	Checking or adjusting ignition timing
22	09900-27002	Checking or adjusting ignition timing
23	09900-28102	Checking electrical equipment
24	09900-28401	Checking battery capacity

Piston holder

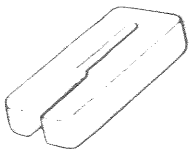

①

Crankshaft remover

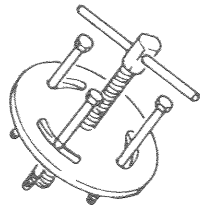

②

Crankshaft assembling tool

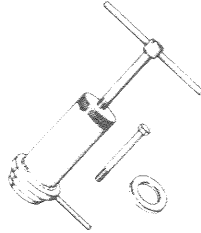

③

Spark plug wrench

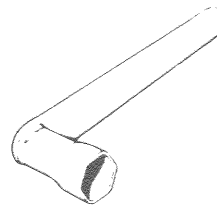

④

8 mm stud installing tool

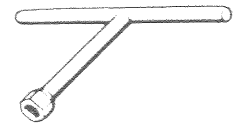

⑤

Flywheel rotor remover

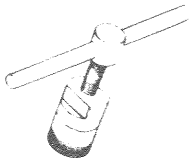

⑥

Flywheel rotor & Engine sprocket holder

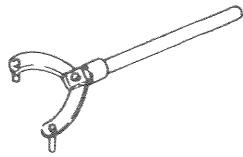

⑦

Contact point wrench



⑧

Clutch sleeve hub holder

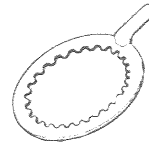

⑨

Clutch sleeve hub holder handle



⑩

Clutch spring hook

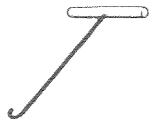

⑪

Bearing & Oil seal installing tool

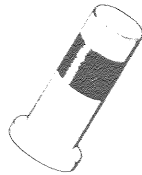

⑫

Bearing & Oil seal installing tool



⑬

Oil seal remover



⑭

Snap ring opener



⑮

Snap ring opener



⑯

Shock driver set

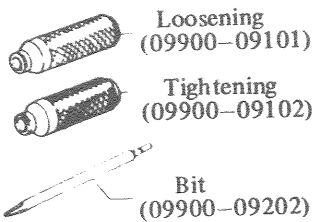

⑰

Exhaust pipe cleaner

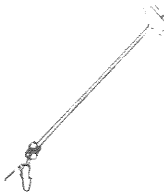

⑱

Steering stem lock nut wrench

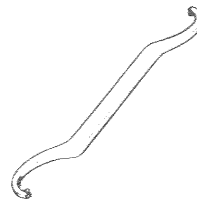

⑲

Front fork outer tube nut wrench set

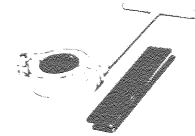

⑳

Timing gauge



㉑

Timing tester

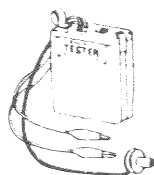

㉒

Electro tester

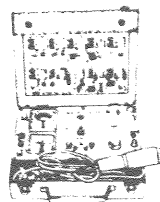

㉓

Hydrometer

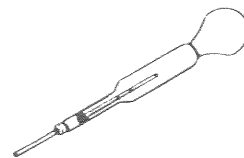

㉔

5. NECESSARY MATERIALS

RV125 necessitates the following materials in addition to the general service equipment, tools and other materials like lubricant, cleaning solvent, emery cloth and so forth. For further details, refer to the pertinent items in this manual.

5-1. THREAD CEMENT



Fig. 5-1-1 Optional part No. 99000-32010

This cement is applied to the thread of screw such as the fitting screw for the shifting cam guide, kick starter stopper and gear shifting arm stopper.

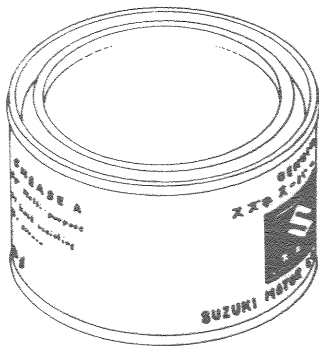

Fig. 5-1-2 Optional part No. 99000-32030

This cement is only used for securing the 2nd drive gear press-fitted over the counter-shaft end. Apply the cement to the inside surface of the gear when pressing it in.

5-2. GREASE

One of these two types should be used for lubrication of the crank and other oil seals. These grease are applied to the inside of oil seal where it meets with a shaft.



A type Optional part No. 99000-25010

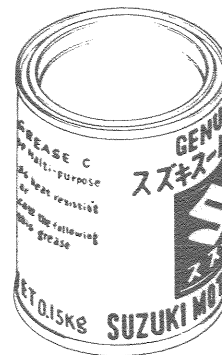

C type Optional part No. 99000-25030

Fig. 5-2-1

6. TROUBLE SHOOTING

When trouble occurs with a motorcycle, it is important to find the source of the trouble as rapidly as possible. It is also necessary to perform only the work required to repair the machine without bothering with parts which are functioning correctly. The list of possible troubles and their causes given below should help the service man to repair motorcycles quickly without loss of effort.

6-1. IF ENGINE IS HARD TO START

Check fuel in the fuel tank first. When a proper amount of fuel is in the tank, check the following points.

Order and Description	Check Points	Remedy
1. Check to see that fuel flows into carburetor	<ul style="list-style-type: none"> * If fuel does not enter into carburetor 1. Fuel strainer clogged 2. Fuel pipe clogged or damaged 3. Tank cap air vent clogged 4. Fuel cock clogged 	<ul style="list-style-type: none"> Remove and clean Clean or replace Clean with wire Clean
2. Check to see that spark jumps in spark plug. (Turn engine with kick starter).	<ul style="list-style-type: none"> * If blue or hot spark jumps in the spark plug, check the following points. 1. Ignition timing 2. Carburetion 3. Engine compression * If spark is weak 1. Damage in spark plug 2. Incorrect spark plug gap 3. Damage in spark plug cap 4. Dirty contact points 5. Bad insulation in condenser 6. Damage in ignition coil * If there is no spark 1. Damage in spark plug 2. Dirty or wet spark plug 3. Incorrect spark plug gap 4. Dirty or incorrect contact point gap 5. Bad insulation in condenser 6. Damage in ignition coil or primary coil 7. Damage in ignition switch 8. Damage in wiring harness 9. Incorrect spark plug heat range 	<ul style="list-style-type: none"> Adjust Adjust Recover it Replace Adjust Replace Clean and adjust Replace Replace Replace Replace Replace Clean Adjust Clean and adjust Replace Replace Replace Repair or replace Replace

<p>3. Check to see that engine compression is proper (Turn engine with kick starter).</p>	<p>* If engine compression is improper</p> <ol style="list-style-type: none"> 1. Cylinder and piston rings worn 2. Piston ring stick on piston 3. Cylinder head gasket damaged 4. Cylinder base gasket damaged 5. Piston damaged 6. Spark plug improperly tightened 7. Spark plug gasket faded 8. Cylinder head improperly tightened 9. Gas leakage from crankcase 10. Cylinder or cylinder head damaged 11. Oil seals damaged 	<p>Repair or replace</p> <p>Repair or replace</p> <p>Replace</p> <p>Replace</p> <p>Replace</p> <p>Tighten securely</p> <p>Replace</p> <p>Tighten securely</p> <p>Repair or replace</p> <p>Replace</p> <p>Replace</p>
---	---	--

6-2. IF ABNORMAL NOISE IS HEARD IN ENGINE

	Check Points	Remedy
	<ol style="list-style-type: none"> 1. Too big clearance between piston and cylinder 2. Too big clearance between piston rings and grooves 3. Piston rings stiff with carbon 4. Con-rod big end worn 5. Con-rod small end bearing worn 6. Piston rings damaged 7. Ignition timing too advanced 8. Defective primary pinion and gear 9. Crankshaft bearings worn 10. Defective transmission gear 11. Defective transmission bearings 	<p>Repair or replace</p> <p>Replace piston</p> <p>Clean</p> <p>Replace</p> <p>Replace</p> <p>Replace</p> <p>Adjust</p> <p>Replace</p> <p>Replace</p> <p>Replace</p> <p>Replace</p>

6-3. IF ENGINE OVERHEATS

If engine overheats at high speed running after it is broken in, check to see if the oiling system is in good condition, the brake is dragging, or cylinder cooling fins are dirty. Inspect the following points.

Description	Check Points	Remedy
<p>1. Check to see if oiling system functions properly.</p>	<ol style="list-style-type: none"> 1. Improperly adjusted oil pump control lever 2. Air in oil lines 3. Oil tank cap breather hole clogged. 4. Incorrect oil used 	<p>Adjust</p> <p>Remove air</p> <p>Repair</p> <p>Use prescribed oil</p>

2. Check to see if engine compression is higher than standard	* Too high compression 1. Carbon deposits in combustion chamber	Remove carbon deposit
3. Check carbon deposit	2. Too thin cylinder head gasket * Check carbon deposit in muffler, exhaust pipe, exhaust port and combustion chamber	Replace Disassemble and remove carbon deposit
4. Check to see that piston rings move smoothly in grooves	* Piston rings stiff by carbon deposit	Remove carbon deposit
5. Check to see that the clutch works properly	Clutch slippage	Adjust
6. Check to see that the ignition timing is correct		Adjust
7. Drive chain too tight		Adjust
8. Incorrect spark plug heat range		Replace with colder plug
9. Too lean fuel mixture		Adjust carburetor

6-4. DEFECTIVE CLUTCH

Description	Check Points	Remedy
1. Clutch slippage	1. Improperly adjusted clutch 2. Clutch springs worn 3. Clutch plates worn	Adjust Replace Replace
2. If clutch drags	1. Improper weight oil 2. Uneven clutch spring tension	Replace Replace

6-5. GEAR SHIFTING TROUBLES

Description	Check Points	Remedy
1. Gear engagement	* If gears do not engage 1. Gear shifting cam groove damaged 2. Gear shifting forks not moved smoothly on cam 3. Gear shifting fork damaged 4. Gears seized	Replace shifting cam Rectify with emery paper Replace Replace
2. Gear shifting lever	* If gear shifting lever does not return to normal position.	

3. Jumping out of gear	1. Gear shifting shaft return spring damaged	Replace
	2. Friction between gear shifting shaft and crankcase	Repair bent shaft or replace
	* If the gears disengage while running.	
	1. Gear shifting fork worn or bent	Replace
	2. Gear dog teeth worn	Replace gear
	3. Gear shifting cam worn or damaged	Replace

6-6. BAD STABILITY AND STEERING

Description	Check Points	Remedy
1. Handlebar is stiff	1. Steering stem lock nut tight 2. Steering stem bent 3. Steel balls damaged	Adjust Repair or replace Replace
2. Handlebar is not stable	1. Incorrect wheel alignment 2. Steel balls damaged 3. Fork stem bent 4. Bearing races worn or damaged 5. Front fork bent 6. Swinging arm bent 7. Fork spring worn	Adjust Replace Repair or replace Replace Repair or replace Repair Replace
3. Wheel is not true	1. Up-and-down play in hub bearings 2. Wheel rim deformed 3. Loose rim fitting nuts 4. Chain too tight 5. Loose swinging arm fitting 6. Frame warped 7. Incorrect tire pressure	Replace Repair or replace Tighten Adjust Tighten Replace Correct

7. ENGINE

7-1. REMOVAL

Prior to the removal operation, thoroughly clean the engine with a steam cleaner or cleaning solvent to remove road dirt. The removal procedure is as follow.



Fig. 7-1-1 Removing frame cover molding

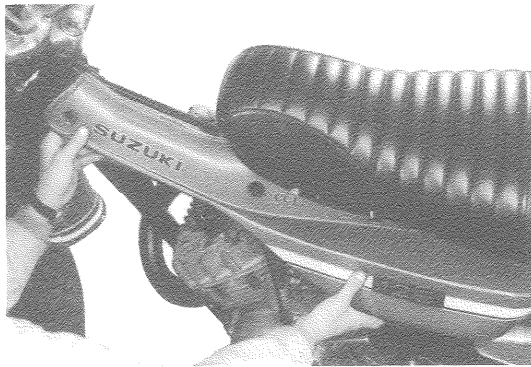

Fig. 7-1-2 Removing frame cover

Required tool:

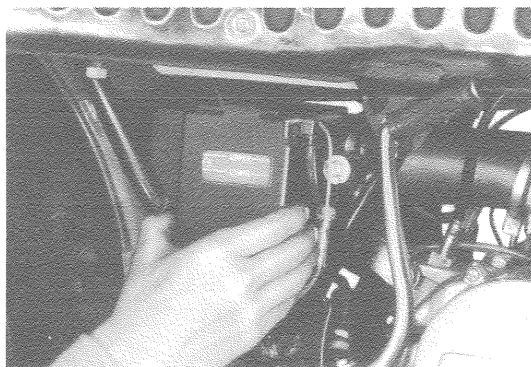
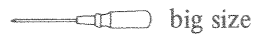

Fig. 7-1-3 Removing battery holder

Required tool:



Tightening torque:

40 ~ 70 Kg-cm (2.9 ~ 5.1 lb-ft)

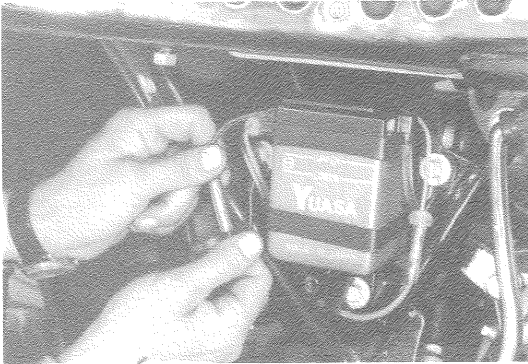

Fig. 7-1-4 Disconnecting battery ground wire

Required tool:



Be sure not to lose the oil seal installed at the joint when removing the cable.

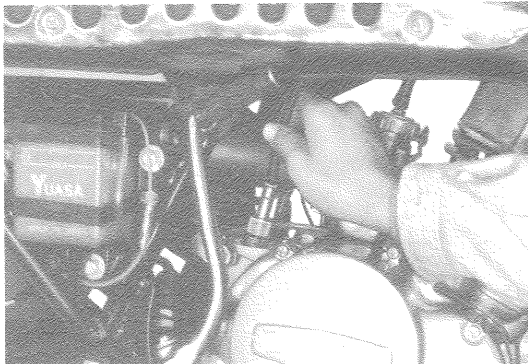

Fig. 7-1-5 Disconnecting tachometer cable

Required tool:



small size

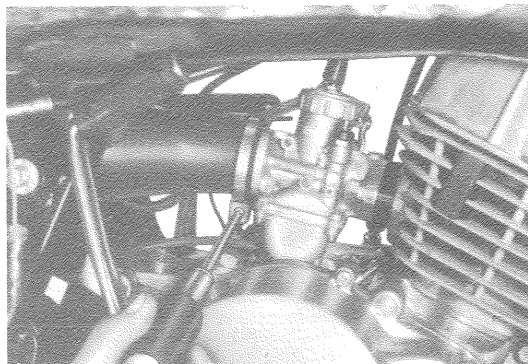

Fig. 7-1-6 Removing carburetor air inlet hose

Required tool:



14 mm

Tightening torque:
250 ~ 400 Kg (18 ~ 29 lb-ft)



Fig. 7-1-7 Removing kick starter lever

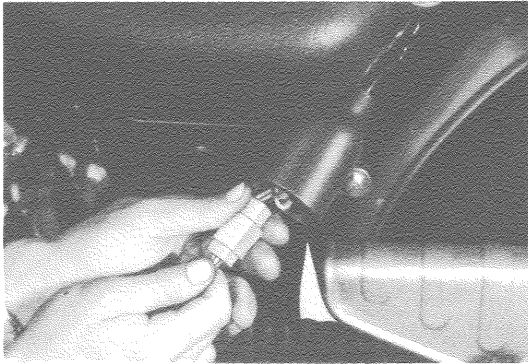

Fig. 7-1-8 Disconnecting magneto lead wire

Disconnect the magneto lead wires at the coupler located behind the air cleaner box.

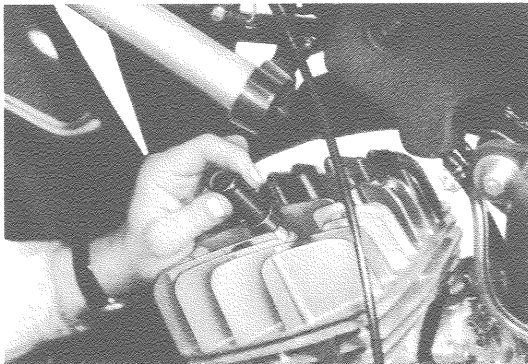

Fig. 7-1-9 Removing spark plug cap

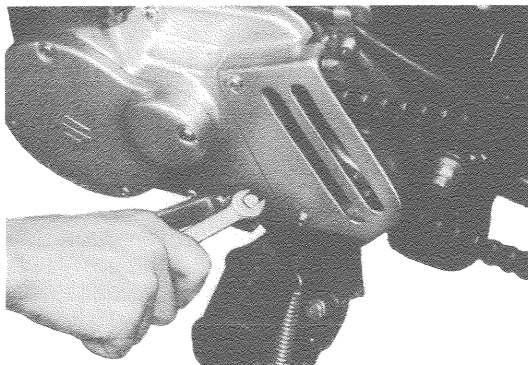
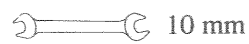

Fig. 7-1-10 Removing gear shift lever

Required tool:



10 mm

Tightening torque:

60 ~ 100 Kg-cm (4.4 ~ 7.3 lb-ft)

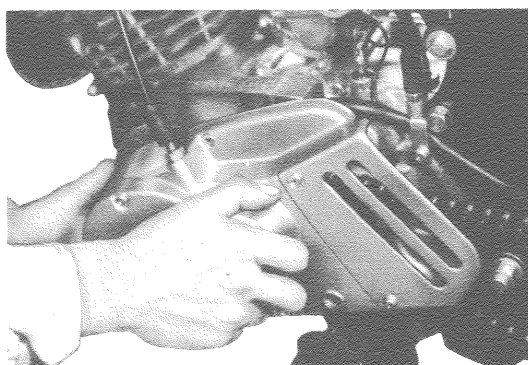

Fig. 7-1-11 Removing crankcase left cover

Required tool:



big size

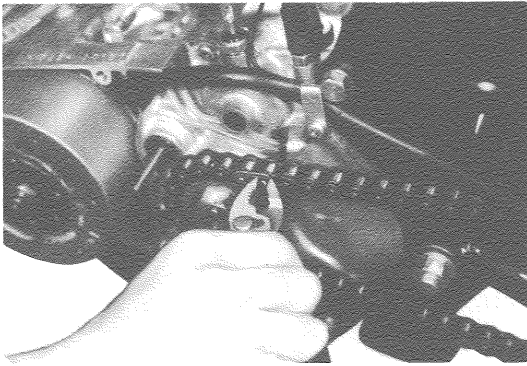

Fig. 7-1-12 Disconnecting ends of drive chain

Required tool:

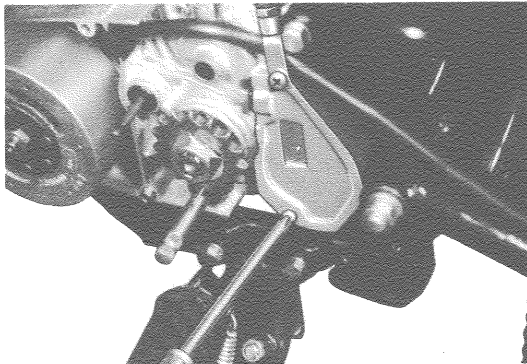

Fig. 7-1-13 Removing oil pump cover

Required tool:

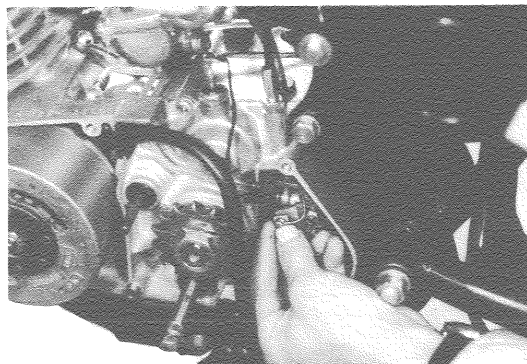

Fig. 7-1-14 Disconnecting oil pump control cable

Disconnect the oil control cable at the oil pump by removing the cable end piece.

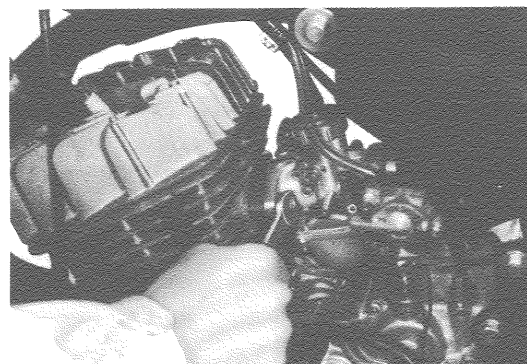

Fig. 7-1-15 Removing carburetor

Required tool:



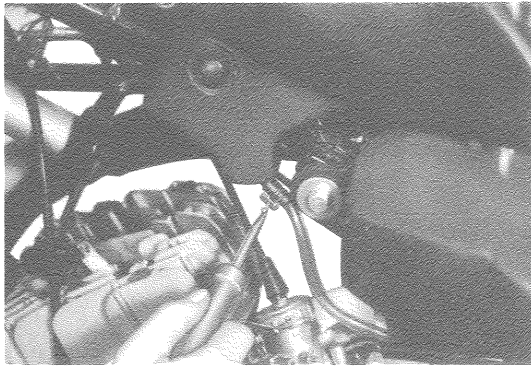

Fig. 7-1-16 Disconnecting oil inlet pipe

Required tool:



small size

Disconnect the oil pump inlet pipe at the oil tank outlet and block the outlet hole by the rubber cap of wheel inner tube inflator valve.

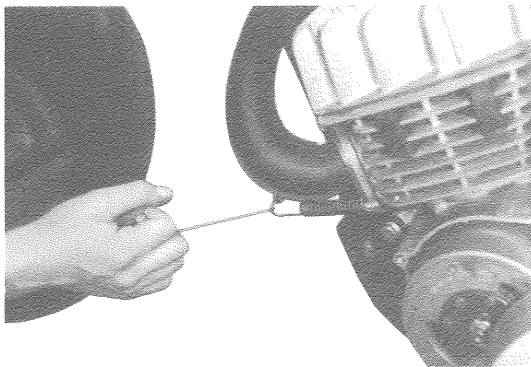

Fig. 7-1-17 Removing exhaust pipe spring

Required tool:



special tool 09920-20310

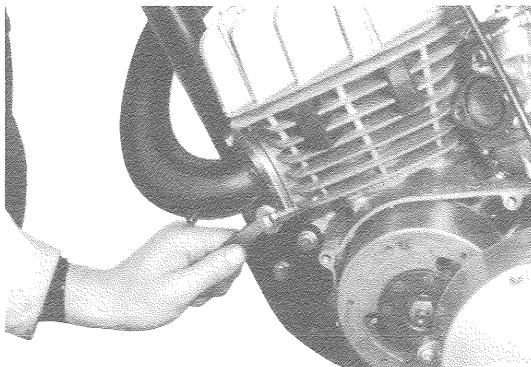

Fig. 7-1-18 Unscrewing exhaust pipe fitting bolt

Required tool:



or 10 mm

Tightening torque:
60 ~ 100 Kg-cm (4.4 ~ 7.3 lb-ft)



Fig. 7-1-19 Removing muffler

Required tool:

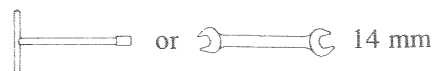

or 14 mm

Tightening torque:
180 ~ 280 Kg-cm (13 ~ 20 lb-ft)

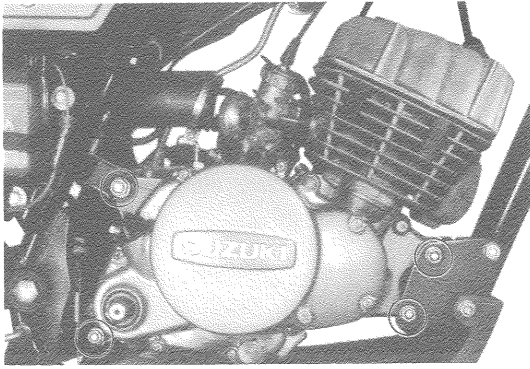
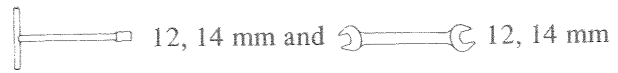

Fig. 7-1-20 Removing engine mounting bolts

Required tool:



Tightening torque:

“S” marked bolt 130 ~ 230 Kg-cm (9.5 ~ 17 lb-ft)

Usual bolt 180 ~ 280 Kg-cm (13 ~ 20 lb-ft)

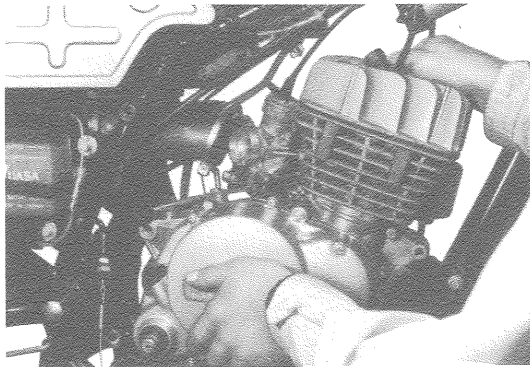

Fig. 7-1-21 Dismounting engine

Lift up the engine and move it.

CAUTION :

Do not pull up or move the engine by holding the gear shifting shaft otherwise the shaft may bend making it difficult to pull the shaft out.

7-2. DISASSEMBLY AND ASSEMBLY

This section gives an explanation of all the jobs necessary for separating the crankcase. When disassembling the engine, take the following steps. For reassembling the engine after necessary inspections or repairs, follow the reverse order of the disassembly.

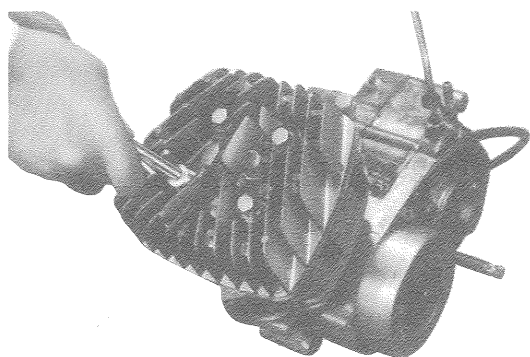
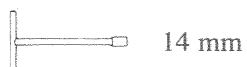

Fig. 7-2-1 Removing cylinder head

1. Remove the cylinder head after unscrewing the fitting nuts.

Required tool:



Tightening torque:

230 ~ 270 Kg-cm (17 ~ 20 lb-ft)

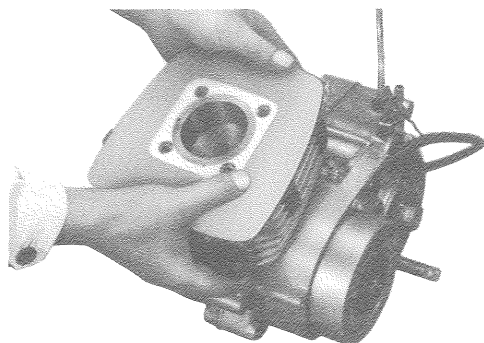

Fig. 7-2-2 Removing cylinder

2. Remove the cylinder by pulling it up.

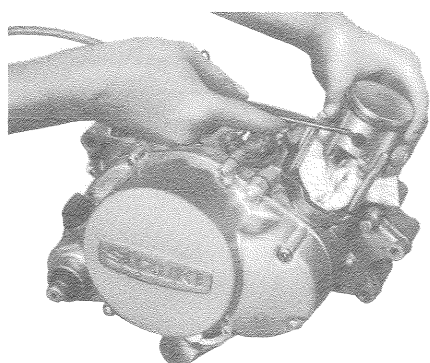

Fig. 7-2-3 Removing piston pin circlip

3. Remove the piston pin circlip from piston.

Required tool:



CAUTION :

Cover the crank chamber with clean rag to prevent a piston pin circlip or a foreign substance from dropping into it.

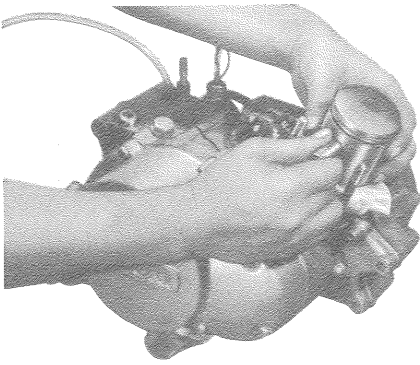

Fig. 7-2-4 Removing piston pin

- Remove the piston pin by pushing the other end of the pin with a rod.

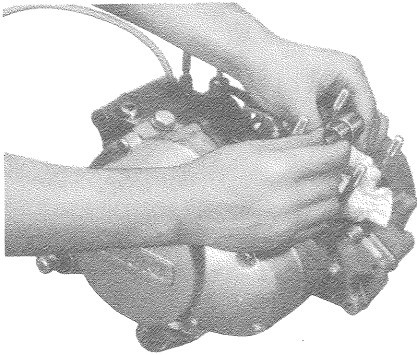

Fig. 7-2-5 Removing piston pin bearing

- Remove the piston pin bearing.

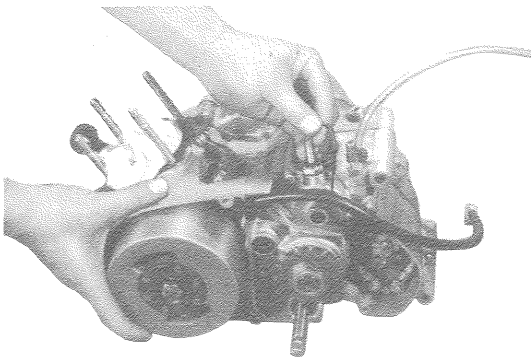

Fig. 7-2-6 Disconnecting neutral indicator switch wire

- Disconnect the neutral indicator switch wire.

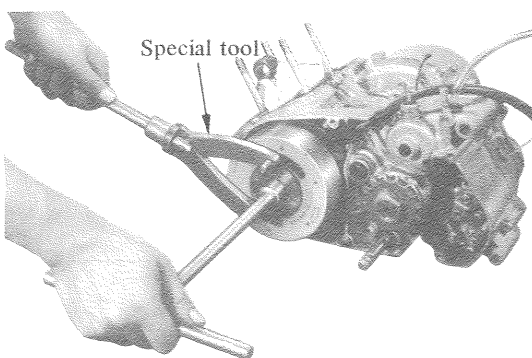
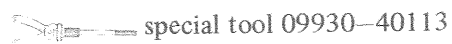

Fig. 7-2-7 Loosening flywheel rotor nut

- Loosen the flywheel rotor nut by holding the rotor with the special tool.

Required tool:



Tightening torque:

300 ~ 400 Kg-cm (22 ~ 29 lb-ft)

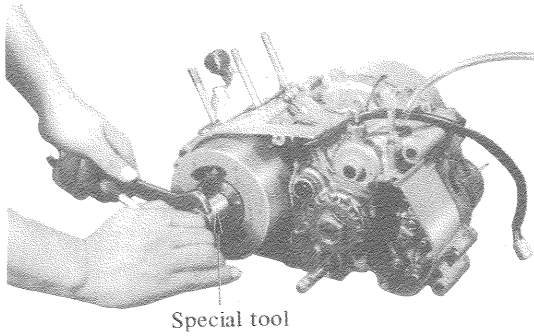

Fig. 7-2-8 Removing flywheel rotor

8. Remove the flywheel rotor with the special tool.

Required tool:

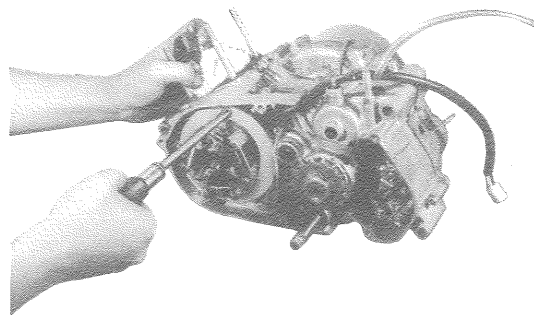
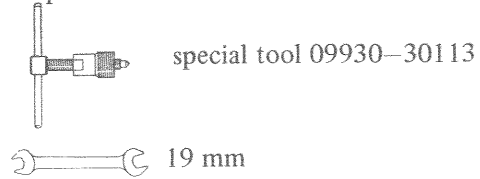

Fig. 7-2-9 Removing magneto stator

9. Remove the magneto stator by unscrewing the fitting screws and woodruff key on the crankshaft.

Required tool:

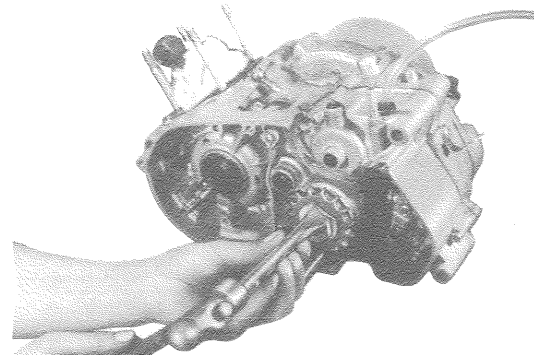
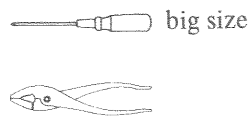

Fig. 7-2-10 Flattening lock washer

10. Flatten the engine sprocket washer with a chisel and a hammer.

Required tool:

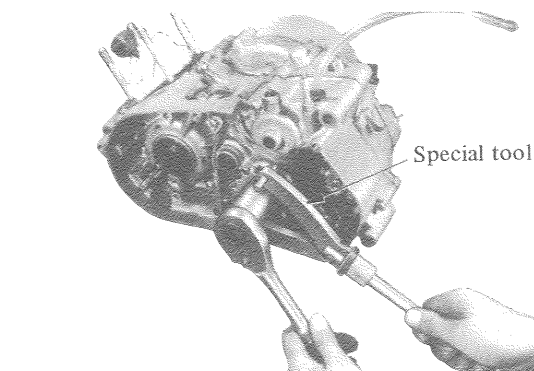
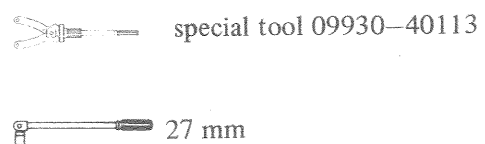

Fig. 7-2-11 Loosening sprocket nut

11. Loosen the sprocket nut by holding the sprocket with the special tool.

Required tool:



Tightening torque:
400 ~ 600 Kg-cm (29 ~ 43 lb-ft)

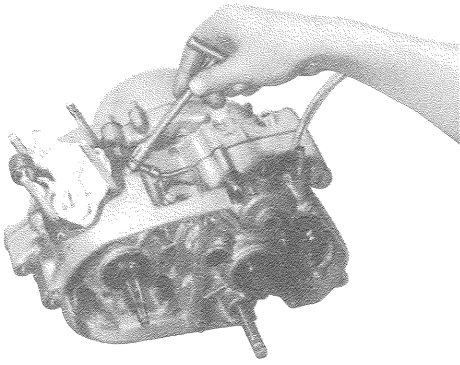

Fig. 7-2-12 Removing oil pipe union bolts

12. Loosen the oil pipe union bolts.

Required tool:



Tightening torque:

20 ~ 30 Kg-cm (1.4 ~ 2.2 lb-ft)

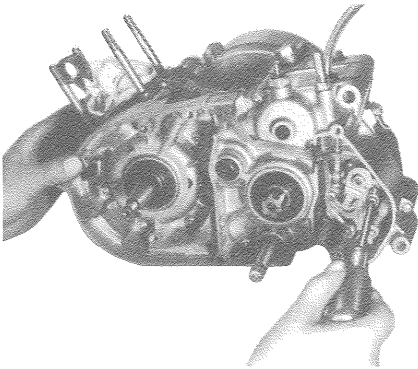

Fig. 7-2-13 Loosening oil pump fitting screws

13. Unscrew 2 pcs of the screws and remove the oil pump.

Required tool:



14. Remove the oil pump driving piece.

Required tool:

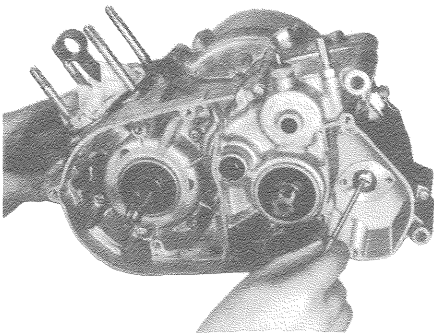

Fig. 7-2-14 Removing oil pump driving piece

15. After loosening the fitting screws, remove the crankcase right cover and oil drain guide.

Required tool:

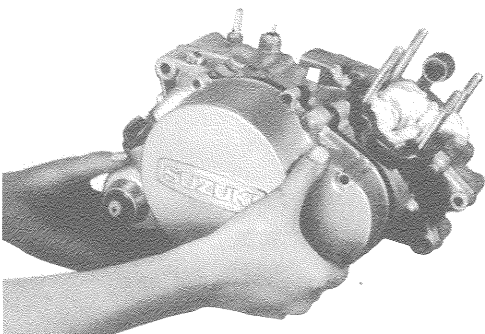

Fig. 7-2-15 Removing crankcase right cover

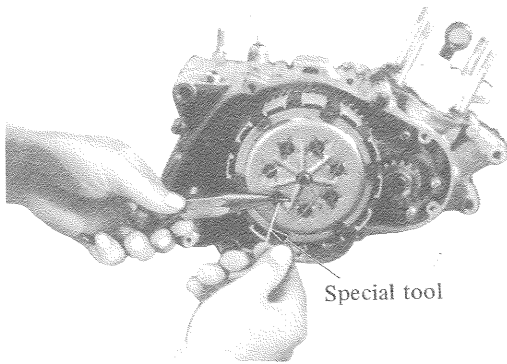

Fig. 7-2-16 Removing clutch spring pins

16. Remove the clutch spring pins by pulling the clutch spring with the special tool.

Required tool:

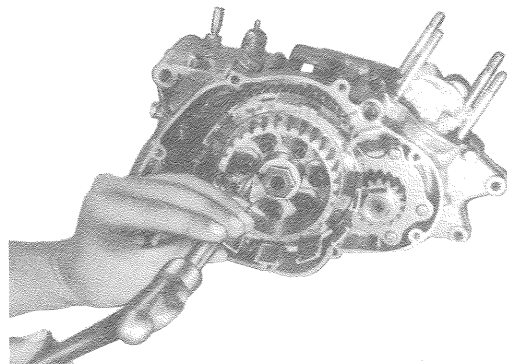
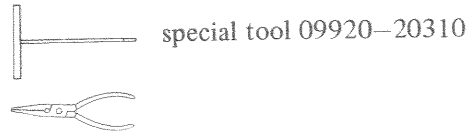

Fig. 7-2-17 Flattening lock washer

17. After removing the clutch plates and the clutch release rod fitted on the end of the shaft by hand, flatten the clutch sleeve hub washer with a chisel and a hammer.

Required tool:

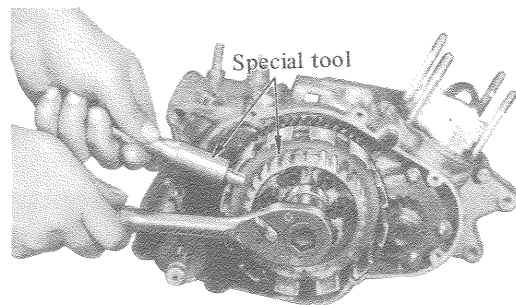
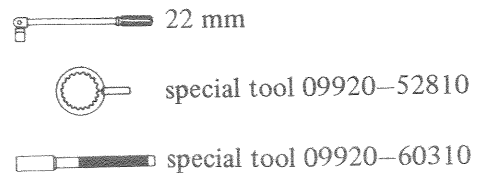

Fig. 7-2-18 Loosening clutch sleeve hub nut

18. Loosen the clutch sleeve hub nut by holding the hub with the special tools.

Required tool:



Tightening torque:

200 ~ 300 Kg-cm (14 ~ 22 lb-ft)

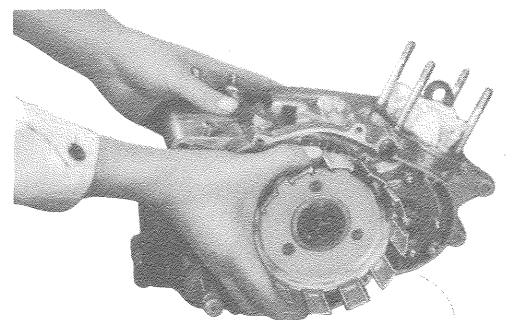

Fig. 7-2-19 Removing clutch housing

19. After taking out the clutch sleeve hub by hand, remove the clutch housing and the primary gear spring.

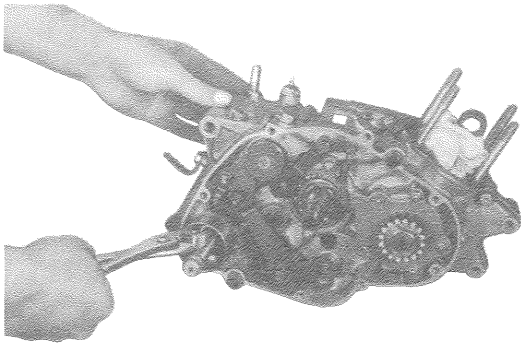

Fig. 7-2-20 Removing shaft spring

20. After taking out the kick shaft spring guide by hand, remove the shaft spring and the spring holder.

Required tool:

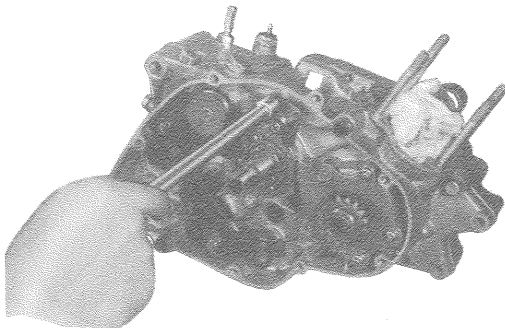

Fig. 7-2-21 Removing shifting cam stopper

21. Remove the shifting cam stopper.

Required tool:

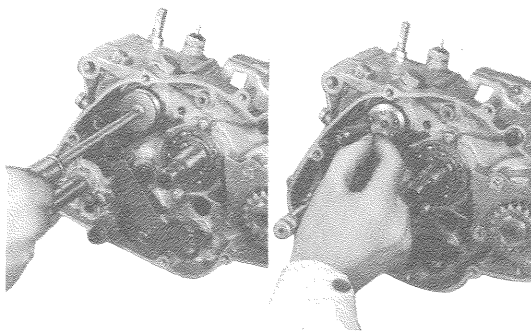

Fig. 7-2-22 Removing shifting cam pins

22. After taking off the shifting cam pin retainer by unscrewing the fitting screw, remove the shifting cam pins.

Required tool:

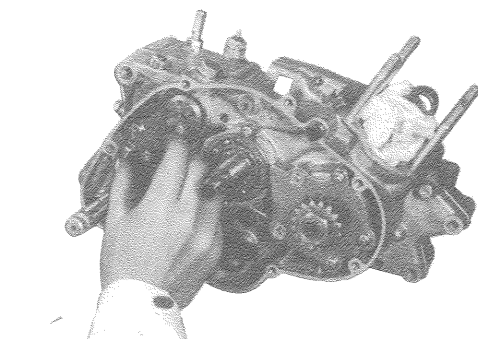

Fig. 7-2-23 Removing cam stopper pawl

23. After removing the cam stopper pawl circlip, take off the cam stopper pawl.

Required tool:



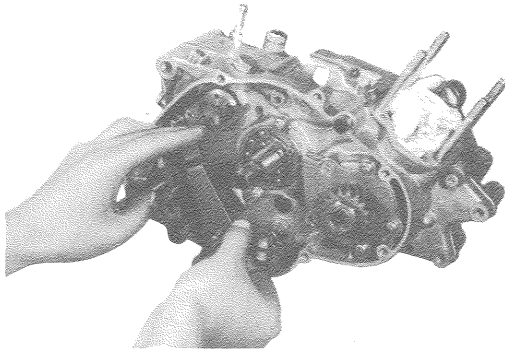

Fig. 7-2-24 Removing gear shifting shaft

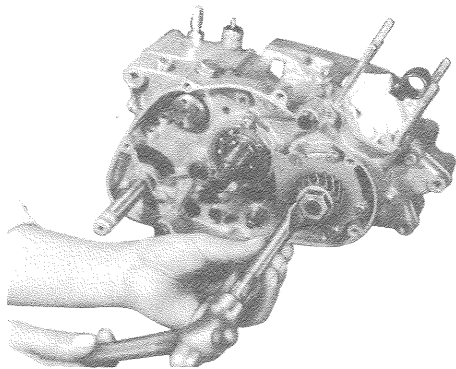

Fig. 7-2-25 Flattening lock washer

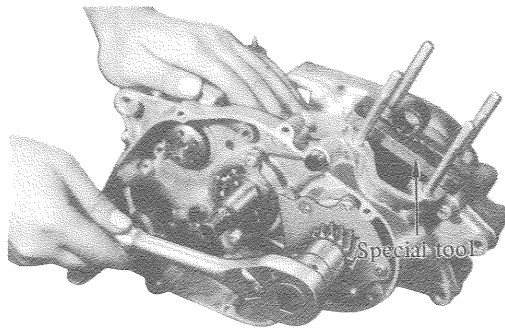

Fig. 7-2-26 Loosening primary pinion nut

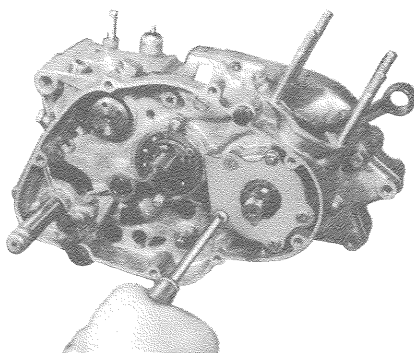

Fig. 7-2-27 Loosening oil reservoir plate fitting screws

24. Pull out the gear shifting shaft.

25. Flatten the primary pinion washer with a chisel and a hammer.

Required tool:



26. Place the piston holder between the connecting rod and the crankcase in order to lock the crankshaft and loosen the primary pinion nut.

Required tool:

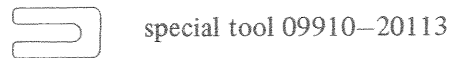

Tightening torque:
400 ~ 550 Kg-cm (29 ~ 40 lb-ft)

27. After taking off the primary pinion key with the pliers, remove the oil reservoir plate by unscrewing its fitting screws.

Required tool:

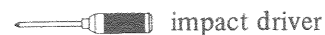

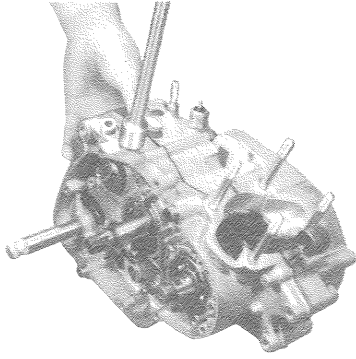

Fig. 7-2-28 Removing gear shifting cam stopper

28. Remove the gear shifting housing together with the cam stopper and the stopper spring.

Required tool:

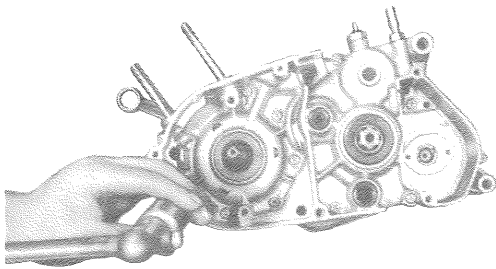

Fig. 7-2-29 Loosening crankcase screws

29. Loosen all the crankcase joining screws on the left crankcase half.

Required tool:

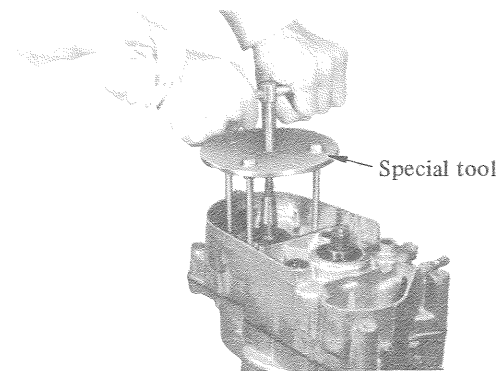
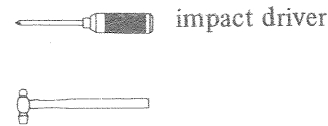

Fig. 7-2-30 Separating crankcase

30. Place the special tool on the left crankcase half and separate it into left and right halves leaving inside parts on the right half of the case.

Required tool:

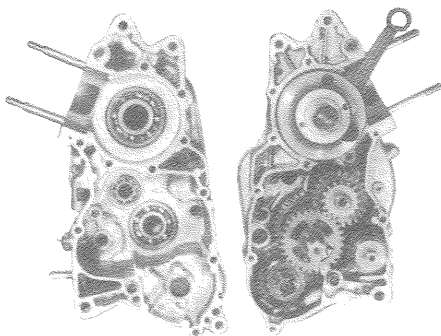
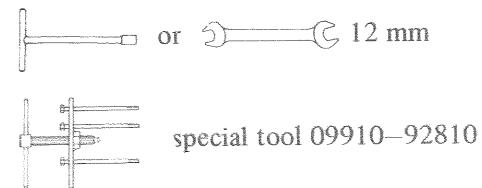

Fig. 7-2-31 Separated crankcase

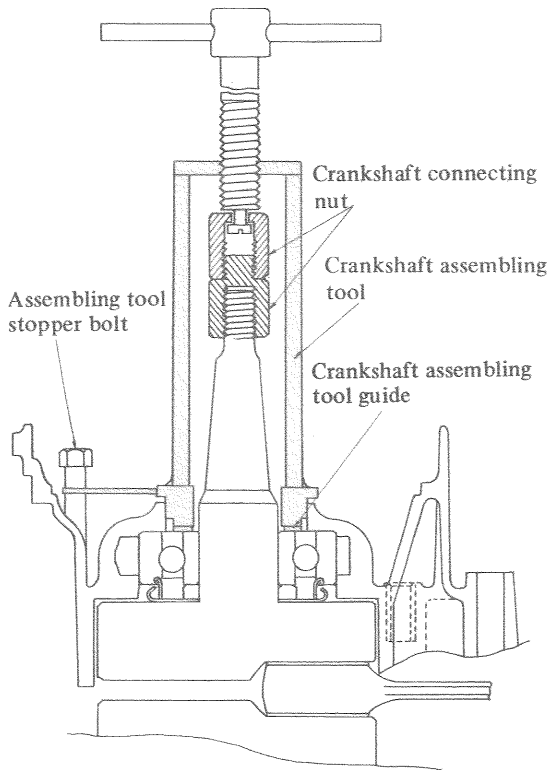

Fig. 7-2-32 Special tool 09910-32811

When combining the left crankcase with the right crankcase, the special tool is required. Place the special tool on the crankcase left half as shown in Fig. 7-2-32 and assemble them by turning the handle of the special tool.

Required tool:

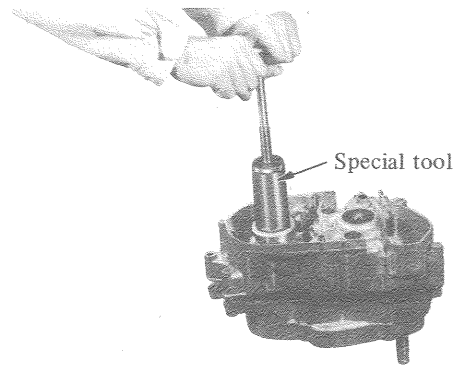
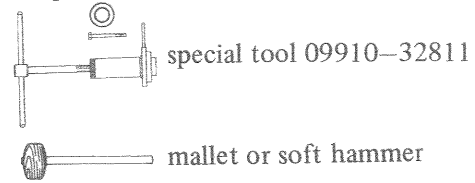

Fig. 7-2-33 Assembling crankcase

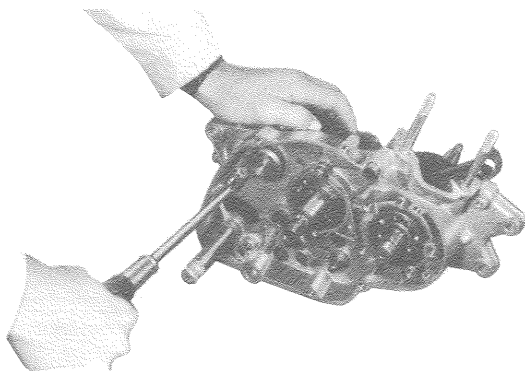

Fig. 7-2-34 Removing cam guide

31. Remove the cam guide.

Required tool:

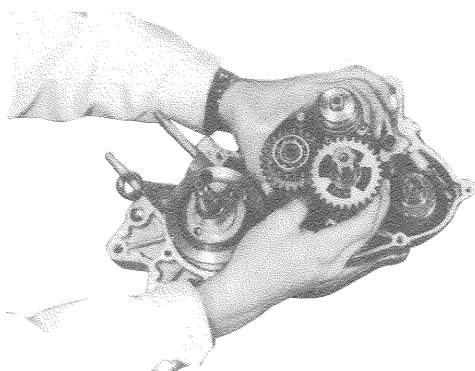

Fig. 7-2-35 Removing transmission parts

32. Remove the transmission parts.

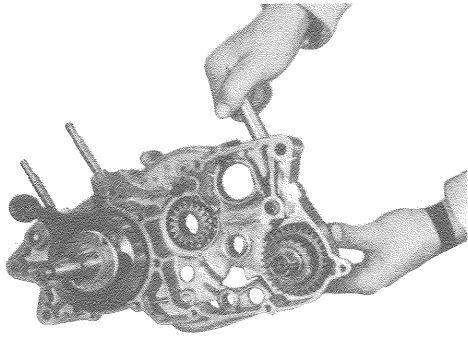
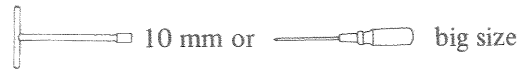

Fig. 7-2-36 Removing tachometer driven gear sleeve

33. After loosening the tachometer gear sleeve bolt, pull out the tachometer driven gear sleeve.

Required tool:



Tightening torque:
40 ~ 70 Kg-cm (2.9 ~ 5.1 lb-ft)

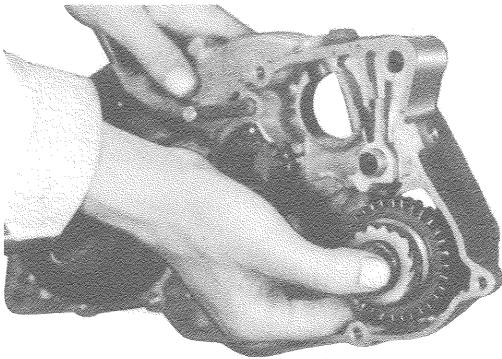

Fig. 7-2-37 Removing kick shaft

34. Remove the kick shaft.

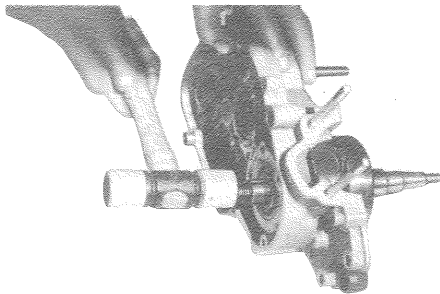

Fig. 7-2-38 Removing crankshaft

35. Remove the crankshaft from the right crankcase half by striking the crankshaft end with the mallet or soft hammer.

Required tool:



7-3. NECESSARY POINTS ON ASSEMBLY

7-3-1. CYLINDER HEAD

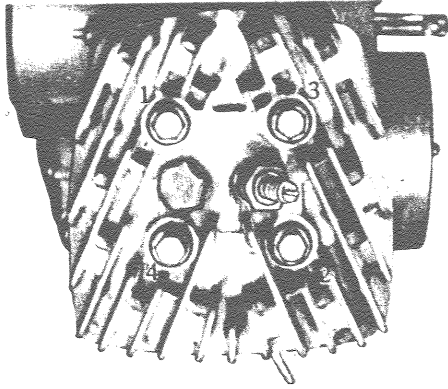

Fig. 7-3-1

When installing the cylinder head, tighten the nuts in a crisscross fashion to prevent cylinder head warp as Fig. 7-3-1.

Tightening torque:
230 ~ 270 Kg-cm (17 ~ 20 lb-ft)

7-3-2. CYLINDER

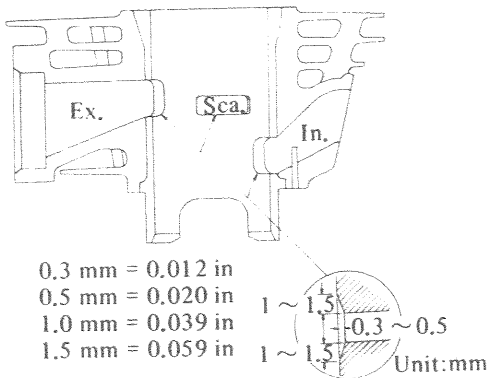

Fig. 7-3-2

In case of installing the rebored cylinder, be sure to check if the edges of the ports are chamfered. If the edges are sharp, chamfer them by a scraper or emery paper.

This will prolong the life of piston and piston rings. The designed chamfer is as illustrated in Fig. 7-3-2.

7-3-3. PISTON

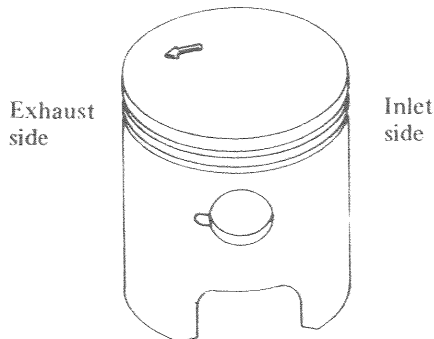

Fig. 7-3-3

The piston pin hole is off-center and the piston skirt is cut according to the shape of scavenging passage on the crankcase, therefore, the piston should be installed in proper direction. The arrow mark on the piston head indicates the exhaust side.

7-3-4. PISTON RING

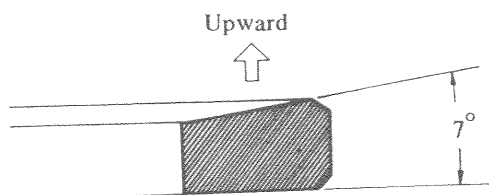

Fig. 7-3-4

- Both the 1st and 2nd rings are of wedge type in their sectional views as illustrated in Fig. 7-3-4 and the ring grooves on piston are machined according to the shape of the rings. Therefore, the ring should be placed in proper direction otherwise the piston will not fit in the cylinder. For identifying upside, a stamped letter is put on the inclined surface.

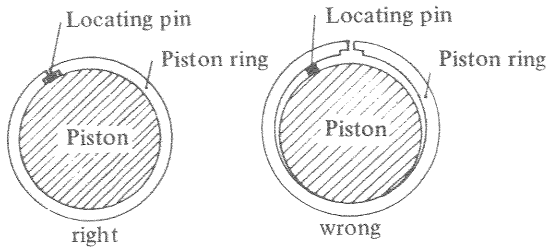

Fig. 7-3-5

7-3-5. CRANKSHAFT OIL SEAL

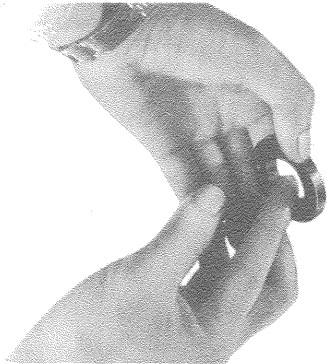

Fig. 7-3-6

7-3-6. ENGINE OIL PIPE

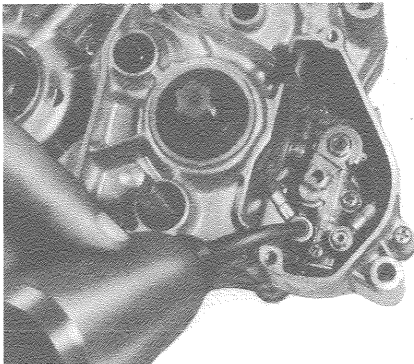

Fig. 7-3-7

7-3-7. CLUTCH

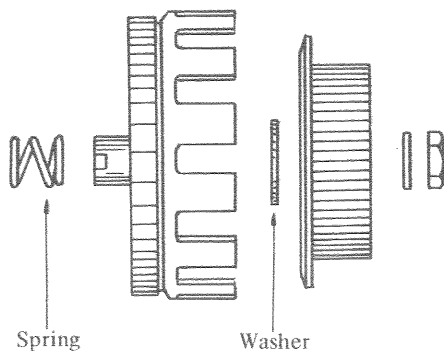

Fig. 7-3-8

- 2) When fitting the piston rings on the piston, align the piston ring open ends with the piston ring locating pin set in the piston ring groove.

When assembling the engine, be sure to replace the right and left crankshaft oil seals with new ones and apply grease all around the lips.

At the time when the engine assembly is completed, the oil passages have not yet been filled with oil. If the engine is started and kept on running in this condition, the engine may suffer lack of lubrication causing a bearing noise or piston seizure. Therefore, be sure to supply CCI Oil from the threaded hole of the union bolt with an oil filler after removing a screw from the top of union bolt as shown in Fig. 7-3-7.

On assembling the clutch, place the washer and the spring in right position as shown in Fig. 7-3-8.

7-3-8. CLUTCH SPRING

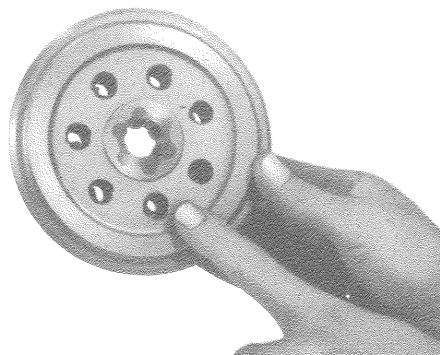

Fig. 7-3-9

When refitting the clutch springs, the clutch spring bottom ends should be kept in the same level with the bottom surface of the clutch sleeve hub so as not to protrude.

7-3-9. CLUTCH PRESSURE PLATE

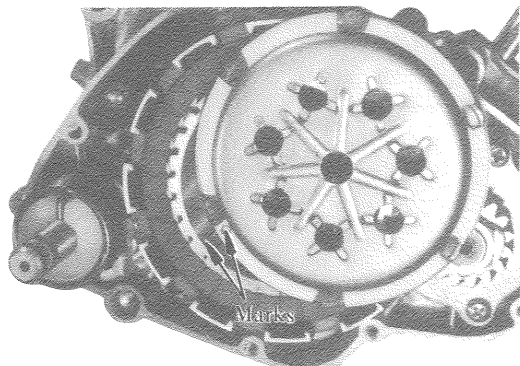

Fig. 7-3-10

When installing the clutch pressure plate, align the positioning mark on the plate with the mark on the edge of the clutch sleeve hub.

7-3-10. GEAR SHIFTING SHAFT RETURN SPRING

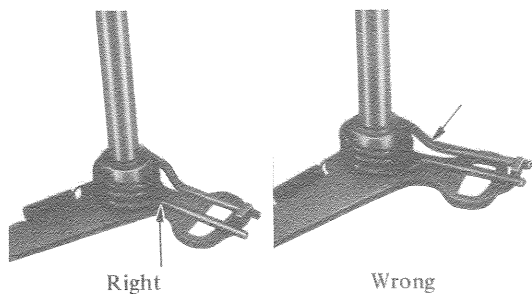

Fig. 7-3-11

When fitting the gear shifting shaft return spring, place the spring with the less-bent side down to the shifting shaft.

7-3-11. GEAR SHIFTING STOPPER PIN

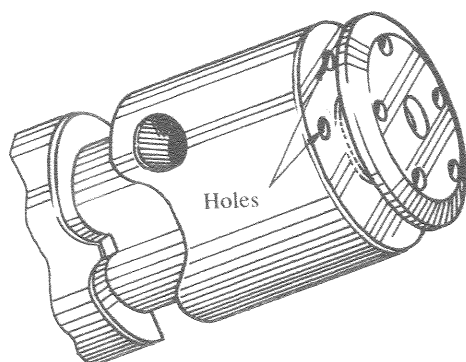

Fig. 7-3-12

When installing the gear shifting stopper pins, place the long ones in the holes of the gear shifting cam as shown in Fig. 7-3-12 and the short pin in the another position.

7-3-12. CRANKCASE

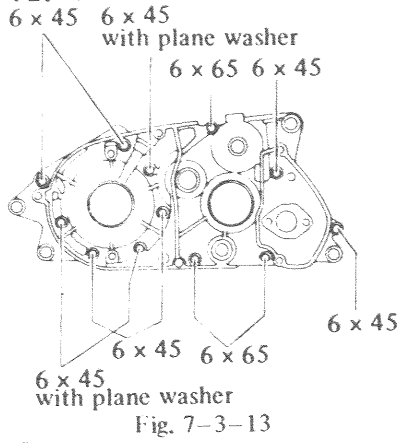
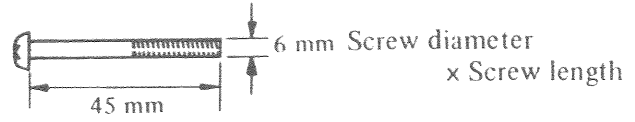

Fig. 7-3-13

After joining the crankcase with the special tool, tighten the crankcase 12 cross head screws evenly in a crisscross fashion from crank chamber side to transmission side in order to prevent the case from warping and the leakage of crank chamber.

* The figures written like 6 x 45 denote the size of the screw:



7-3-13. GEAR SHIFTING FORK

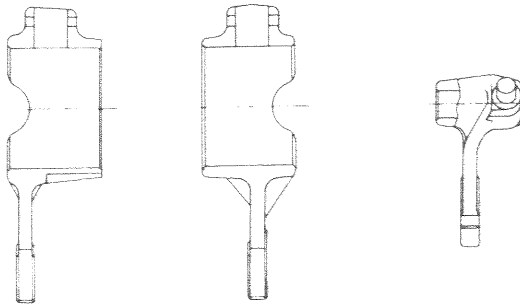

For 4th driven gear For 5th driven gear For 3rd drive gear

Fig. 7-3-14

There are 3 pcs of the gear shifting forks in the transmission and each gear shifting fork has a different shape.

These shapes are drawn in Fig. 7-3-14.

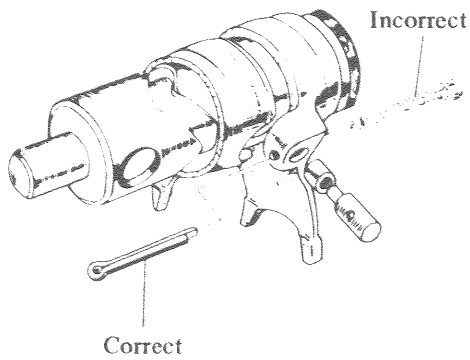

Fig. 7-3-15

When installing the gear shifting fork for 4th driven gear on the shifting cam, be sure to insert the cotter pin from the round side and bend its ends open tightly against the flat surface.

7-3-14. TRANSMISSION

For the installation of gears, washers, circlips, refer to the illustration Fig. 7-3-16.

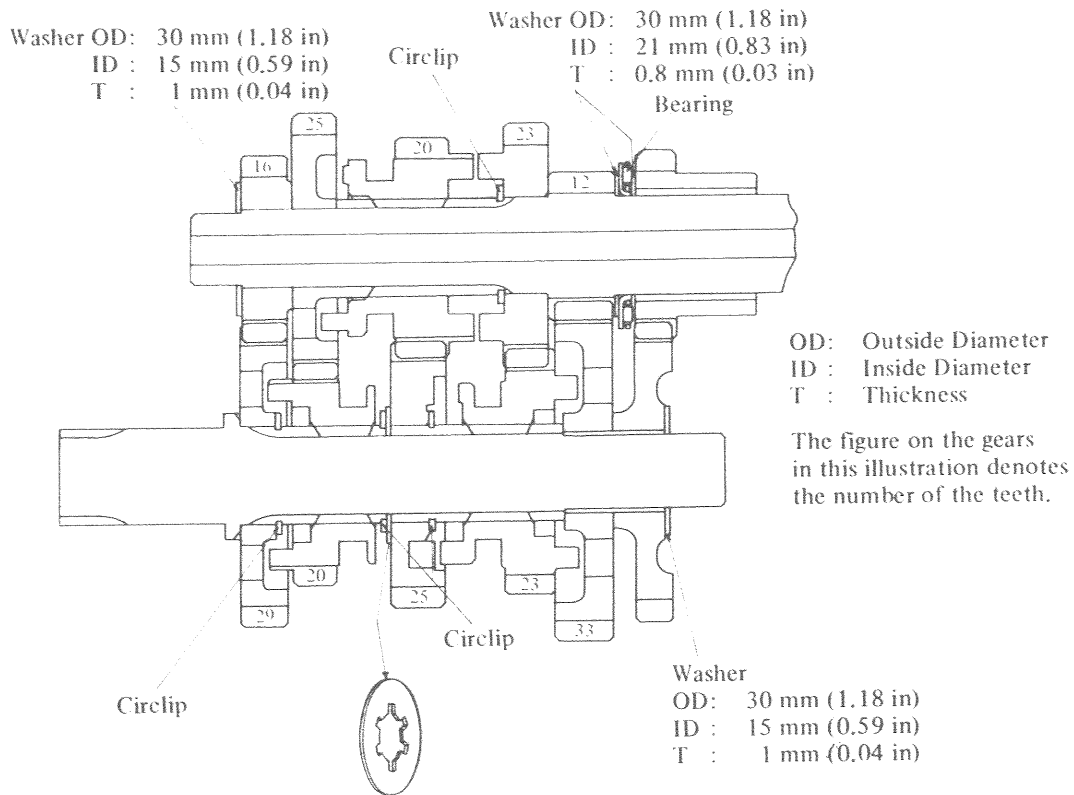

Fig. 7-3-16

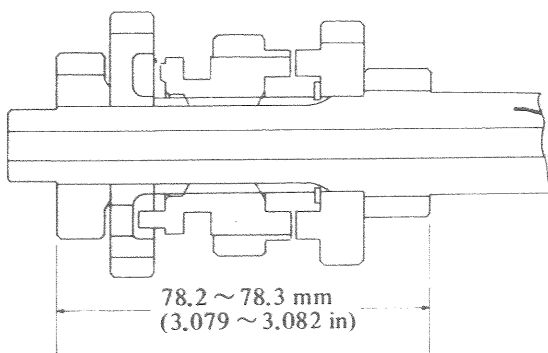

Fig. 7-3-17

The job of replacing the gears on the countershaft may scarcely be required. However, in case that this job is necessarily done, the 2nd drive gear installed by press-fit should be removed.

When installing the 2nd drive gear on the countershaft, the following points should be observed.

- 1) Since the 2nd gear must transmit large torque of the countershaft, enough capacity in frictional force is required at the joint surface of the 2nd gear and countershaft. Suzuki Lock Super 103Q (available as the genuine part) is cement applied to a joint of two materials to increase the frictional force to a great extent. When installing the 2nd gear by press-fit, apply this cement to inside surface of the 2nd gear.
- 2) The press-fit should be made so as to have 78.2 ~ 78.3 mm (3.079 ~ 3.082 in) from the low gear end to the end of 2nd gear as shown in Fig. 7-3-17.
After reassembling the countershaft, check to see if the 5th gear turns smoothly.
- 3) Removal of the 2nd gear from the countershaft is allowable only twice. At the third removal, replace with a new countershaft.

7-3-15. KICK STARTER

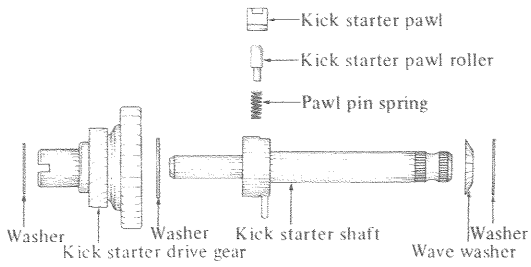

Fig. 7-3-18

The component parts of the kick starter mechanism should be assembled as illustrated in Fig. 7-3-18.

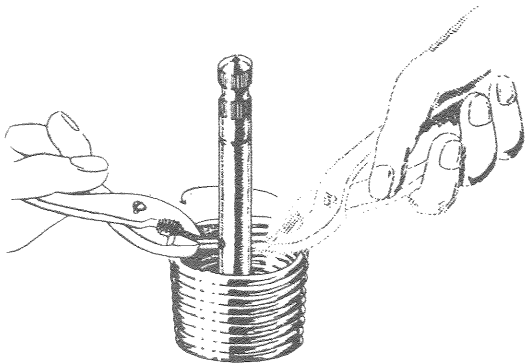

Fig. 7-3-19

When installing the kick starter shaft return spring, turn the shaft rightward all the way and insert the end of the spring into the hole of the shaft by twisting about half a turn with pliers.

7-3-16. DRIVE SHAFT BUSH

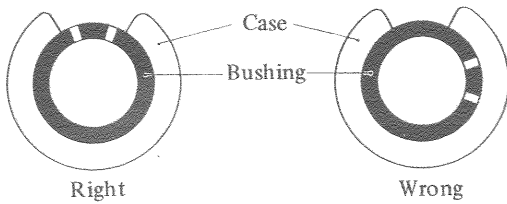

Fig. 7-3-20

When replacing the drive shaft bush with a new one, install the bush as illustrated in Fig. 7-3-20.

7-4. ENGINE LUBRICATION SYSTEM

7-4-1. CONSTRUCTION

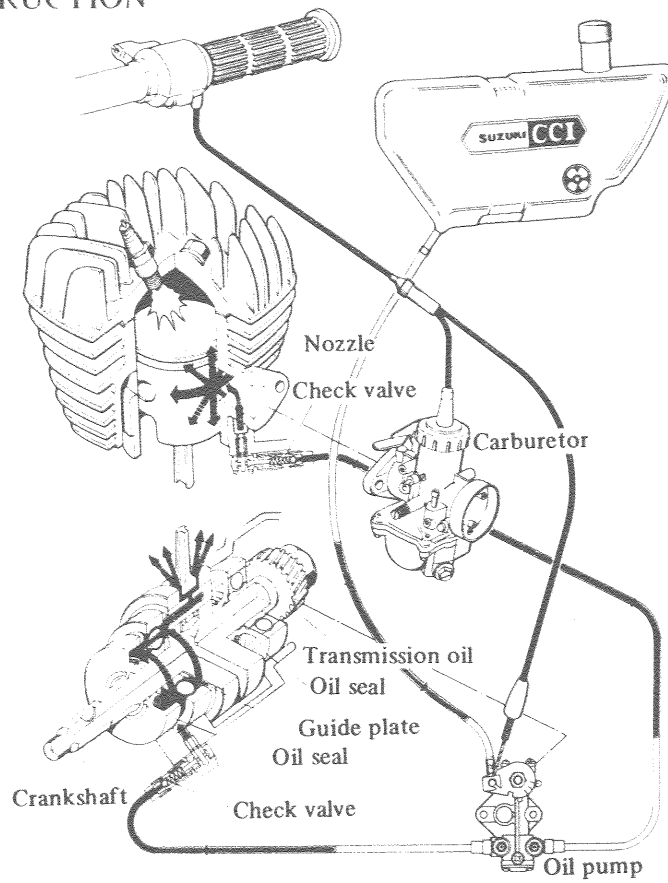

Fig. 7-4-1 Suzuki CCI lubrication system

The engine lubrication is of Suzuki CCI system same as other Suzuki models. Oil which is fed under pressure through two outlet pipes by an oil pump lubricates all the moving parts of the engine except the right crankshaft bearing which is lubricated by transmission oil. The oil pump is driven by a kick starter pinion and the driving power is transmitted from the engine through the clutch, the kick starter driven gear and the kick starter idle gear.

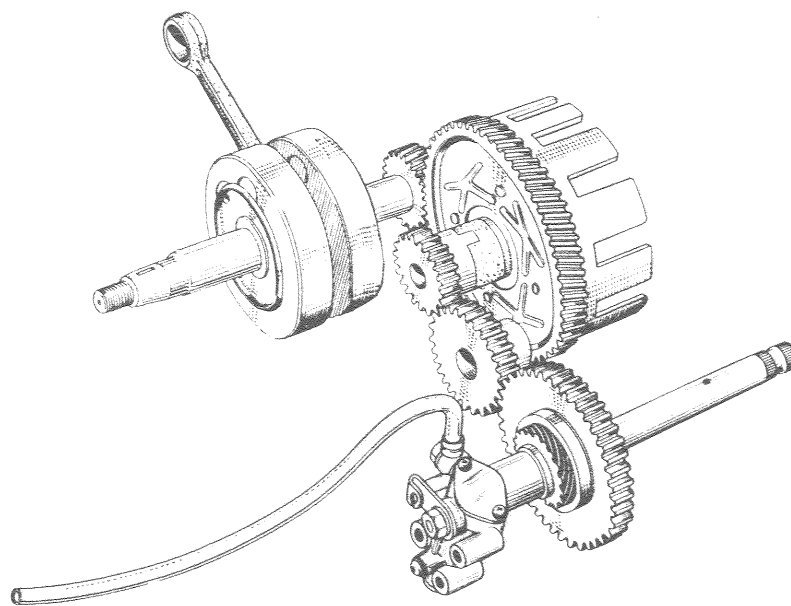

Fig. 7-4-2 Oil pump driving system

7-4-2. OIL PUMP PERFORMANCE

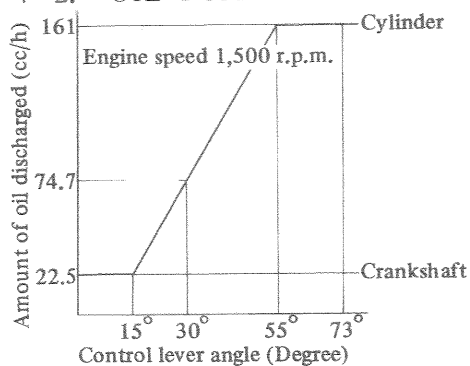

Fig. 7-4-3

The oil pump performance is shown in Fig. 7-4-3.

Gear	Teeth
Primary pinion	16
Primary gear	57
Kick starter gear	18
Kick starter idle gear	29
Kick starter pinion	31

Oil pump reduction ratio
 $57/16 \times 31/18 = 6.13 : 1$

7-4-3. ADJUSTMENT

Since the oil discharging amount of the oil pump is regulated by the throttle wire connected to the control lever on the oil pump in relation to the throttle opening, the throttle wire adjustment must be considered to be very important factor for affecting engine lubricating condition.

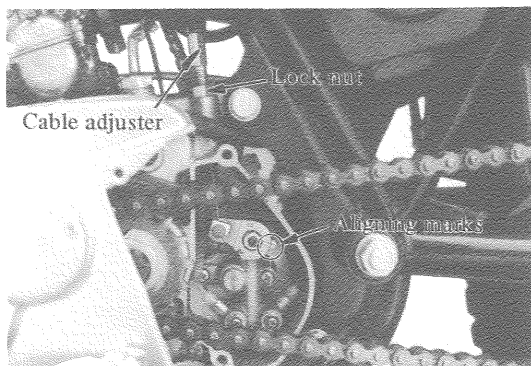

Fig. 7-4-4

To adjust the oil pump by the throttle cable, perform the following procedure.

Holding the throttle grip in wide open, adjust the cable adjuster so that a score on the oil pump lever aligns with the marking on the body. Fig. 7-4-4.

NOTE :

The adjustment in this section should be done after the throttle wire adjustment for the carburetor has been made. The reverse procedure may cause the maladjustment of the oil pump.

7-4-4. BLEEDING OF OIL LINES

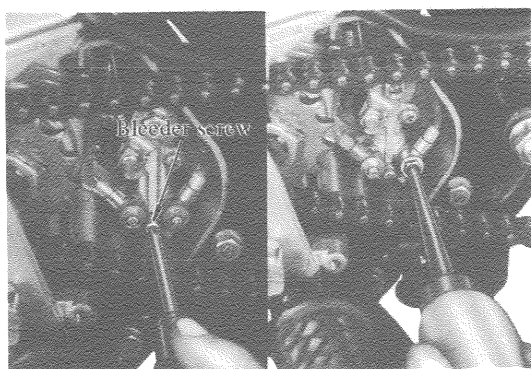

Fig. 7-4-5

In case air is found in the oil inlet pipe, bleed the line by loosening the bleeder screw. If air is in the oil outlet pipes, remove the screw on the union bolt and send oil with a oil filler to expel air.

7-5. CARBURETOR

7-5-1. SPECIFICATION

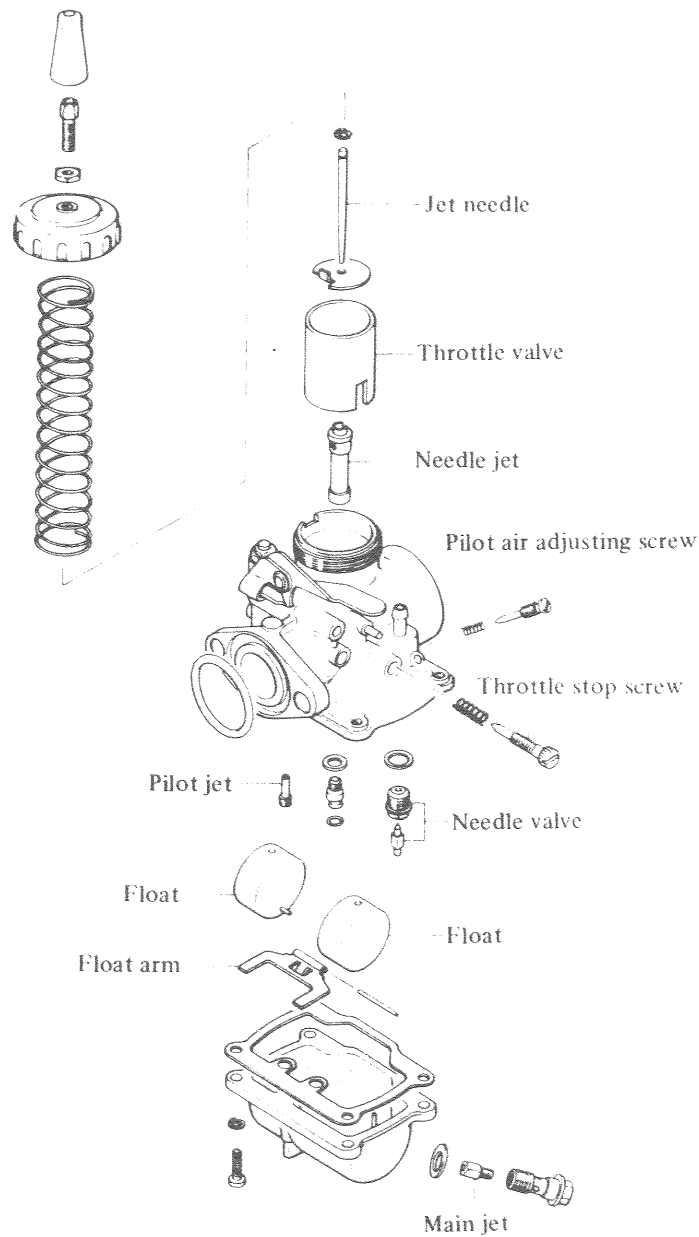

Fig. 7-5-1



Type	VM22SH
Main Jet	#92.5
Jet Needle	4F 10-3
Needle Jet	P-2
Throttle Valve Cut-away	3.0
Pilot Jet	25
By-pass	1.4
Pilot Outlet	0.7
Pilot Air Adjusting Screw	1 ¼ turns back
Needle Valve Seat	1.8
Starter Jet	#80

7-5-2. ADJUSTMENT

I. CARBURETION

The adequate carburetion is determined according to the result of various tests mainly in consideration of engine power, fuel consumption and fuel cooling effect to the engine and jet settings are done so as to satisfy and balance all these conditions. Therefore, it is not recommended to replace the jet with the other size than original or to change the setting position of adjustable parts except when compensating the mixture ratio due to the different altitude or climate conditions. When the adjustment is necessarily required, carry out the job referring to the following points.

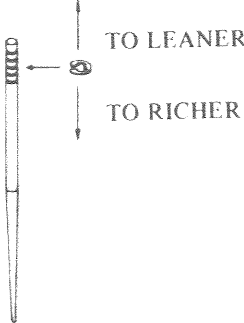
1) Fuel-air mixture ratio can be changed by following manners.

THROTTLE OPENING	METHOD TO CHANGE THE RATIO	STANDARD SET
SLIGHT	<p>PILOT AIR ADJUSTING SCREW</p> 	1 1/4
MEDIUM	<p>JET NEEDLE</p> 	3RD POSITION FROM TOP GROOVE
HIGH	<p>MAIN JET</p>  <p>Larger number : Richer mixture Smaller number : Leaner mixture</p>	NUMBER : 92.5

2) The fuel level inside the float chamber should also be set in proper position. To adjust the fuel level, follow the steps given below.

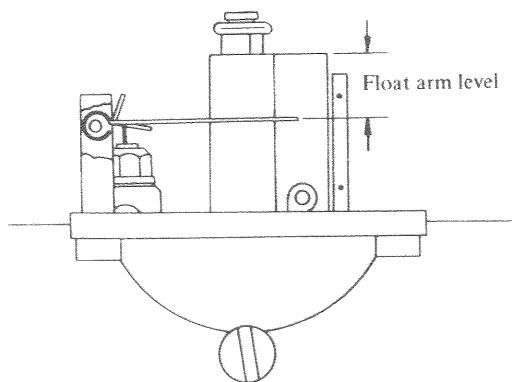

Fig. 7-5-2

- * Remove the float chamber.
- * Hold the carburetor upside down.
- * Hold the float arm just when the float tongue touches the upper end of the needle valve.
- * Measure the distance between the float arm and the needle jet setter fitting surface as shown in Fig. 7-5-2.

STANDARD DISTANCE: 6.8 mm (0.268 in)

II. IDLING ADJUSTMENT

The following procedures should be performed to balance the working condition of the carburetor in engine idling speed as follow.

- * Start the engine and allow it to warm up.
- * After the engine warms up, stop it momentarily. Screw the pilot air adjusting screw all the way in and screw out $1\frac{1}{4}$ turns.
- * Start the engine again and adjust the throttle valve stop screw so the engine runs at the lowest steady speed.

7-6. STARTER SYSTEM

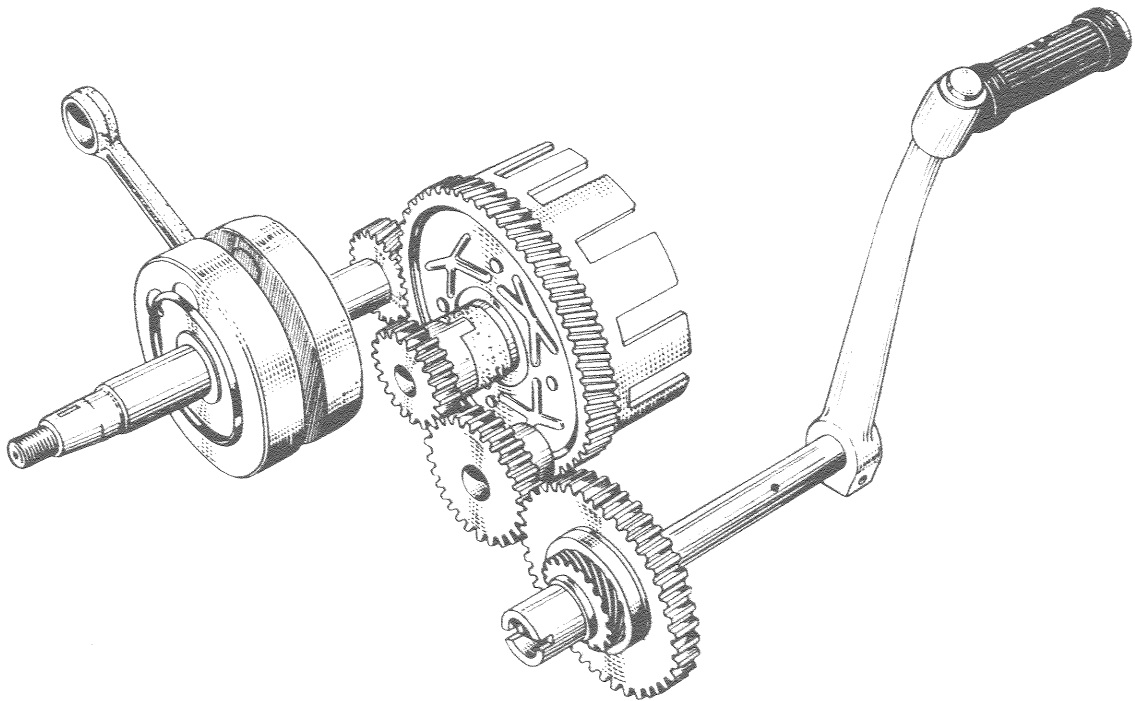
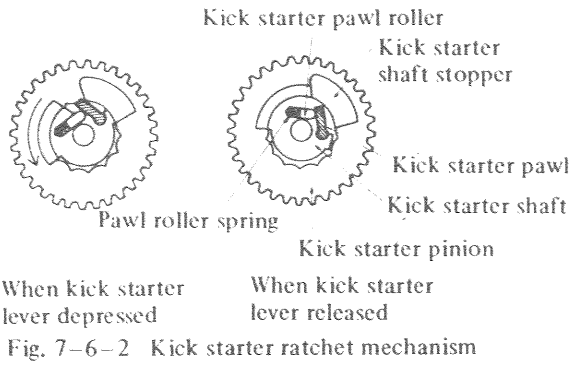

Fig. 7-6-1

As the kick starter system is of a primary kick starting type, the engine can be started regardless of the gear position when the clutch is disengaged. The kick starting torque is transmitted to crankshaft through the kick starter pinion, the kick starter idle gear, the kick starter gear, the primary driven gear and the primary pinion as shown in Fig. 7-6-1.



Inside the kick starter pinion is installed a ratchet mechanism consisting of a pawl, pawl roller and pawl spring so that engine revolutions are not transmitted to the kick starter shaft after the engine is started. When turning the kick starter shaft counterclockwise, the kick starter pawl fitted in the kick starter shaft engages with the kick pinion inside tooth, and the kick pinion is caused to turn and the crankshaft is also turned by the rotation of the kick pinion. When the starter lever is returned to its normal position by the return spring, the kick starter pawl is pressed into the kick shaft by the kick starter stopper.

7-7. CLUTCH

7-7-1. CONSTRUCTION

The clutch is of wet multi-disc type and its construction is as shown in Fig. 7-7-1.

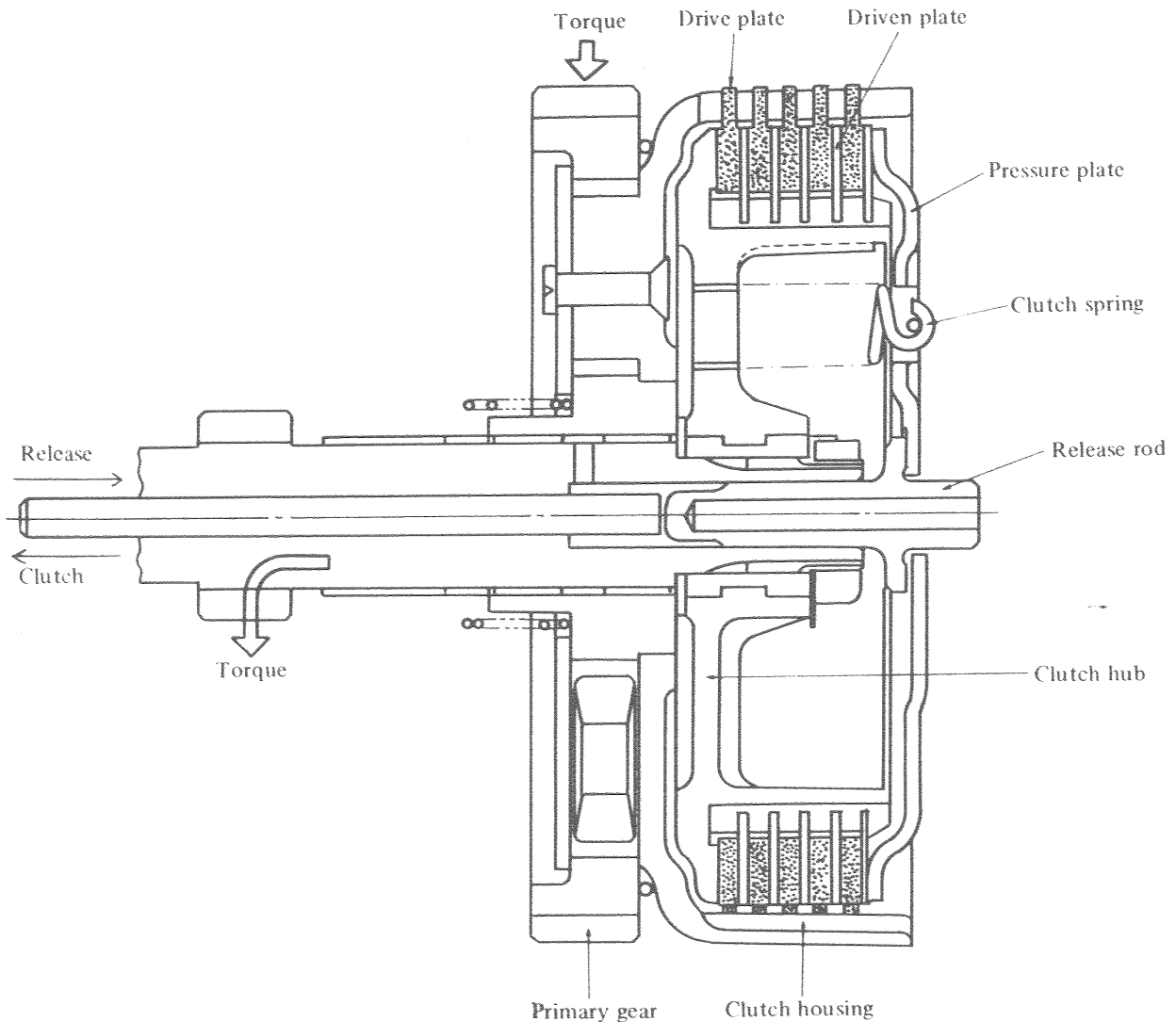

Fig. 7-7-1

7-7-2. ADJUSTMENT

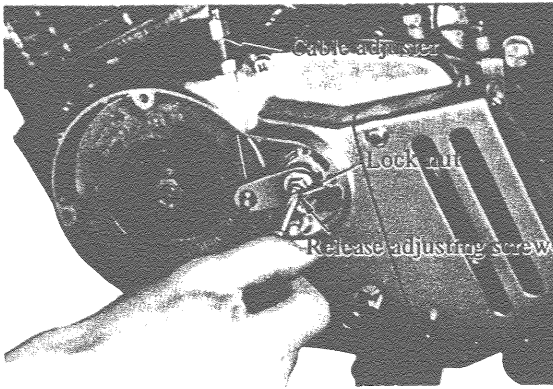

Fig. 7-7-2 Clutch release screw

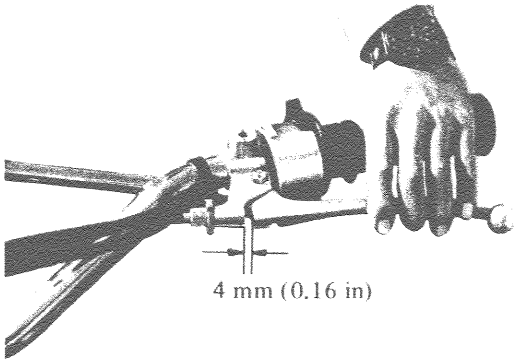

Fig. 7-7-3 Cable end play

The clutch can be adjusted by both the clutch cable adjuster and the release adjusting screw. However, the adjustment should be normally made in the state that the clutch release screw is fully returned, therefore, the maximum play should be made on clutch cable before the adjustment.

- * Loosen the clutch release screw lock nut.
- * Screw in the release adjusting screw until it stops and turn it back around half a turn, then tighten the lock nut.
- * Adjust the cable adjuster so that the cable end play at the clutch lever may be around 4 mm (0.16 in).

7-8. TRANSMISSION

7-8-1. CONSTRUCTION

The type of the transmission is constant mesh 5 speed. The construction and working principle are explained in this section.

Engine power is transmitted to the drive shaft through the clutch, countershaft, gears on the countershaft and gears on the drive shaft. From the drive shaft to the rear wheel, the power is further transmitted through the drive sprocket, drive chain and driven sprocket.

Each one set of drive and driven gear is used for each speed and these two gears are always paired so that one gear is free and the other gear is fixed on the related shaft in its turning direction. The sliding gears shown in the illustration can move axially and clutch their facing free gears with dogs, which enable the free gears to be fixed with shaft. This movement is done by the gear shifting forks.

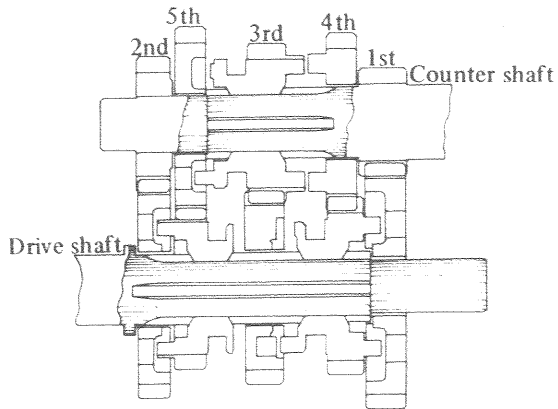

Fig. 7-8-1 Neutral position

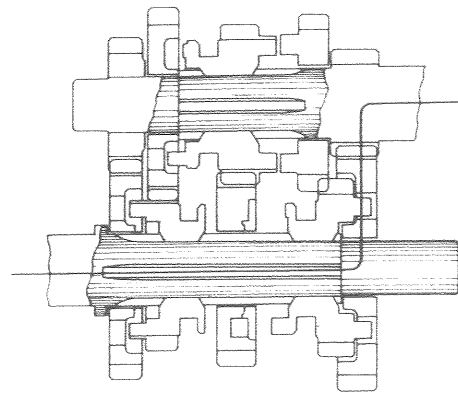

Fig. 7-8-2 1st position

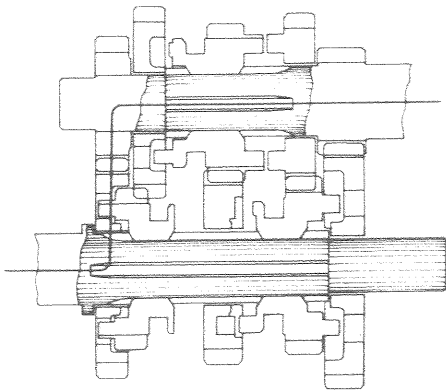

Fig. 7-8-3 2nd position

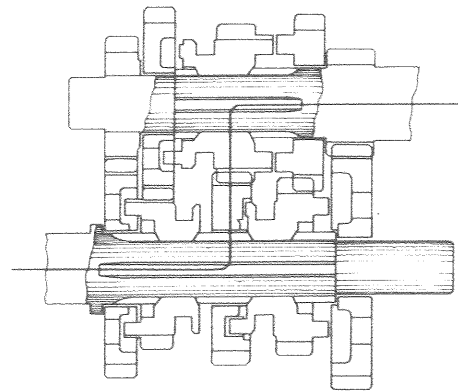

Fig. 7-8-4 3rd position

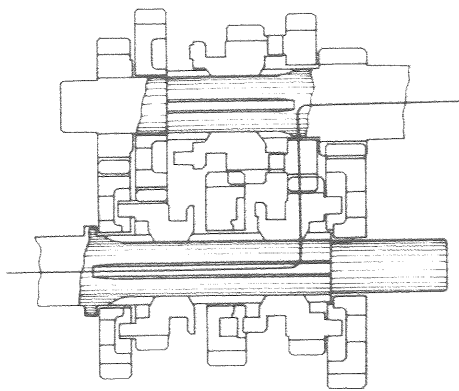

Fig. 7-8-5 4th position

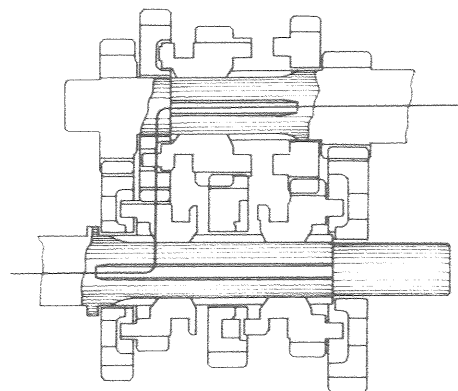

Fig. 7-8-6 5th position

7-8-2. TRANSMISSION OIL

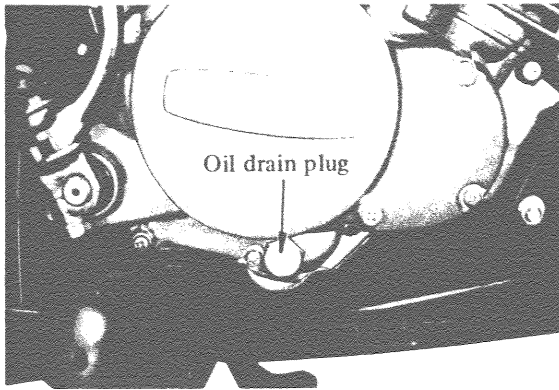

Fig. 7-8-7 Oil drain plug

When disassembling the engine or changing the transmission oil at the time of the periodic inspection, fill with 550 cc of Suzuki transmission oil.

If Suzuki transmission oil is not available, a good quality 20W/40 multi-grade motor oil may be used instead.

7-9. AIR CLEANER

7-9-1. CONSTRUCTION

The element is made of washable spongy plastics and contains oil in it so as to further prevent the penetration of dust. The construction is shown in Fig. 7-9-1.

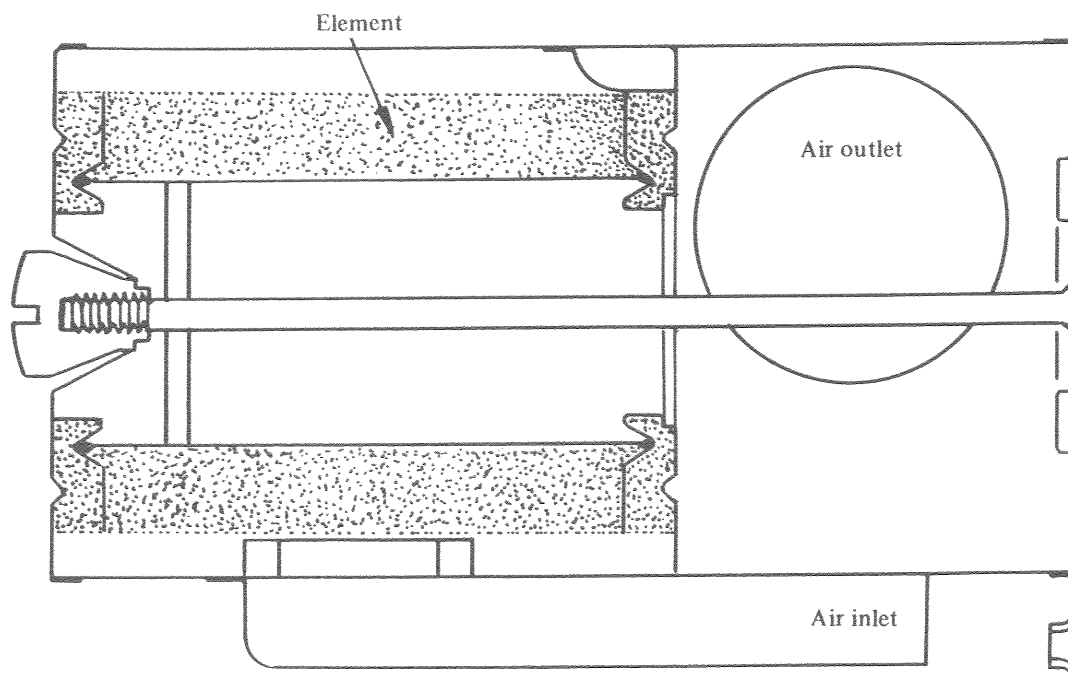

Fig. 7-9-1

7-9-2. MAINTENANCE

When cleaning the element, take it out and wash with clean petrol. After draining the element, soak it into Suzuki CCI Oil or other two-stroke oil of around SAE No. 30 and squeeze oil from the element.

NOTE : When reinstalling the element to the air cleaner body, set the element so that it is parallel with the longitudinal axis of the air cleaner body. If the element is fitted aslant, the fuel air mixture becomes too rich.

7-10. ENGINE ELECTRICAL

7-10-1. IGNITION SYSTEM

I. WIRING

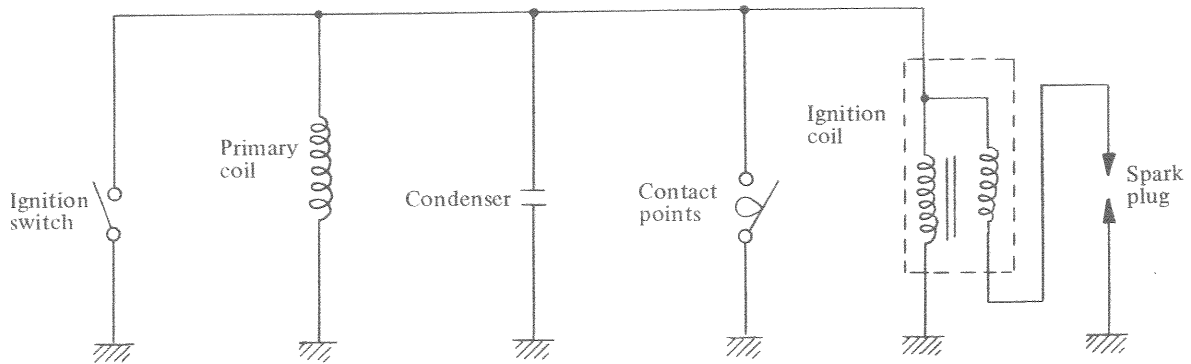

Fig. 7-10-1

The flywheel magneto type ignition system has the electrical wiring as shown in Fig. 7-10-1. When the flywheel magneto is rotated, a current is generated within the primary coil mounted on the stator. With the breaker points closed, the current generated in the primary coil flows to the ground through the points as the primary coil is grounded, giving no influence on the primary coil in the ignition coil. When the contact points open the current induced in the primary coil flows into the primary coil in the ignition coil allowing a high voltage to be induced within the secondary coil, thereby causing a spark to jump across the spark plug electrodes.

II. ADJUSTING IGNITION TIMING

The ignition timing of the usual motorcycle can be adjusted separately from the point gap by rotating the flywheel magneto stator but, as the flywheel magneto stator of this model is not movable, it can be adjusted only by increasing or decreasing the point gap.

To adjust the ignition timing, perform the following procedures.

- 1) Remove the spark plug from the cylinder head and install the timing dial gauge (special tool 09931-00112) on a spark plug hole.
- 2) Connect one end of lead wire of the timing tester (special tool 09900-27002) to Black/Yellow coloured lead wire of the flywheel magneto and the other lead wire to the ground.
- 3) Search T.D.C. in the dial gauge by turning the crankshaft slowly and set the dial face to zero at T.D.C.



Fig. 7-10-2 Attaching timing dial gauge

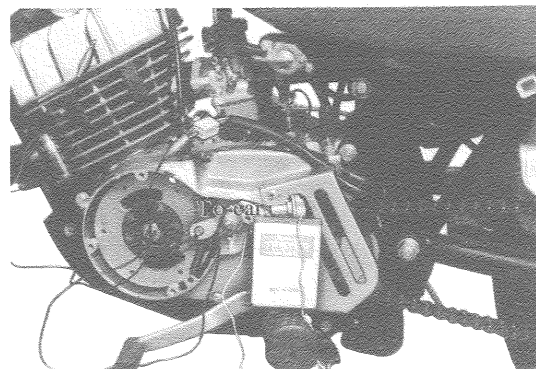

Fig. 7-10-3 Connecting timing tester

- 4) Turn the crankshaft slowly clockwise, that is, reverse direction of engine rotation, and stop turning the crankshaft where the sound of the timing tester just dies away.

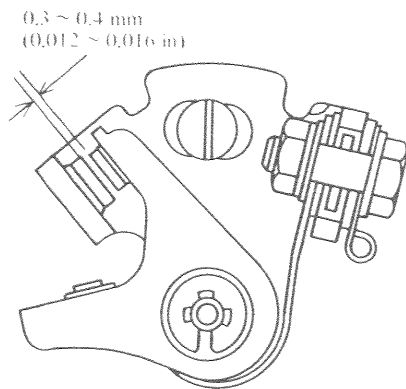

Fig. 7-10-4 point gap

- 5) Read the indication of dial gauge. This reading shows the ignition timing in piston travel from T.D.C.

STANDARD IGNITION TIMING :
 2.41 mm ($22^{\circ} \pm 2^{\circ}$)
 Allowance 1.99 ~ 2.85 mm

- 6) If the ignition timing is out of the above standard, adjust it by increasing or decreasing the point gap within 0.3 ~ 0.4 mm.

NOTE : The magneto is designed originally so as to obtain the standard ignition timing at 0.3 ~ 0.4 mm of the point gap.

Therefore, if the point gap is out of the standard value (0.3 ~ 0.4 mm) in the condition that the ignition timing is adjusted correctly, it is necessary to renew the contact points because this is supposed due to the excessive wear or the deformation of the contact points.

III. INSPECTING PARTS

1) PRIMARY COIL

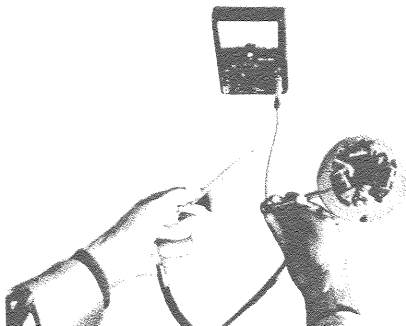

Fig. 7-10-5

Check the conductivity and the resistance of the primary coil using a pocket tester as shown in Fig. 7-10-6.

Standard resistance is about 2.0 Ω

2) IGNITION COIL

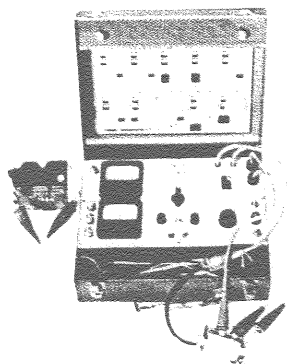

Fig. 7-10-6

Check the ignition coil performance as shown in Fig. 7-10-7 using a battery as the electric source for the electro tester. Connect the primary coil terminal to the tester primary side positive terminal and the ignition coil fitting stay to the tester primary side negative terminal. Connect the high tension cord of the ignition coil to the tester secondary side positive terminal and the ignition coil fitting stay to the negative terminal. Check the three prong gap of the electro tester when spark is jumping across. Standard spark performance is over 7 mm (0.276 in).

3) CONDENSER

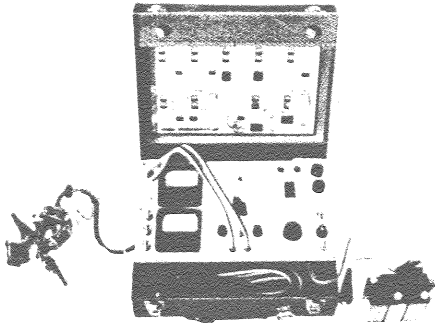

Fig. 7-10-7

① Checking insulation

Set the electro tester to the “insulation resistance” position. Touch the two tester terminals to the condenser terminal and the body respectively. The condenser is in good condition if the tester needle deflects for a moment and then returns to its normal position (over 10 megohms) and stops. If the insulation is insufficient, the tester needle will not return to its normal position.

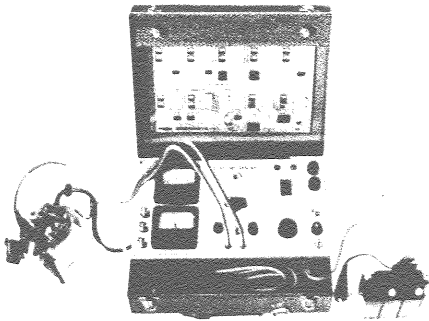

Fig. 7-10-8

- #### ② Set the electro tester to the “condenser capacity” position to measure capacity accurately. With the tumbler switch pulled down to “cal” position, align the tester needle with the standard capacity (μF) stamped on the identification plate which is attached to the side of the electro tester by turning the adjuster. Push the tumbler switch to the “test” position and connect the inspection terminals to the condenser terminals. Standard condenser capacity is $0.18 \mu\text{F}$.

7-10-2. CHARGING SYSTEM

I. WIRING

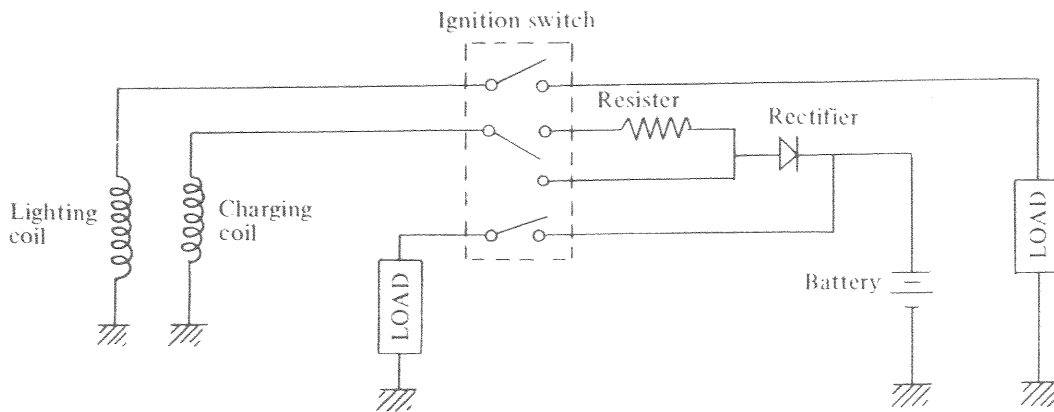

Fig. 7-10-9

The charging system using a flywheel magneto is shown in Fig. 7-10-10. The charging coil and the lamp coil are fitted on the magneto stator and generate alternating current when the flywheel rotor turns. The charging system has two circuits, one is engaged by setting the ignition switch to the day time position and another to the night time position.

* Operation in day time

When the motorcycle is operated in day time, alternating current generated in the charging coil flows to the rectifier through the resistor and is rectified to direct current. The direct current is charged to the battery, and activates the stop lamp, turn signal lamp and horn.

* Operation in night time

Operation of the motorcycle at night necessitates the use of head lamp, speedometer lamp and tachometer lamp, and these electrical loads are activated by alternating current generated in the lamp coil. Alternating current generated in the charging coil is rectified to direct current and charged to the battery through the rectifier and delivered to the tail lamp, stop lamp, turn signal lamp and horn.

II. INSPECTING PARTS

1) CHARGING COIL AND LAMP COIL

Check conductivity and resistance of the charging coil and the lamp coil using a pocket tester.

STANDARD RESISTANCE : CHARGING COIL about 0.7 Ω
LAMP COIL about 0.6 Ω

2) RESISTOR

Check conductivity and resistance of the resistor using a pocket tester.

STANDARD RESISTANCE : 3.6 ~ 4.4 Ω

3) RECTIFIER

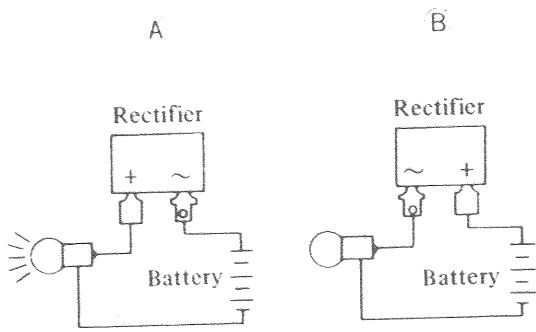

Fig. 7-10-10

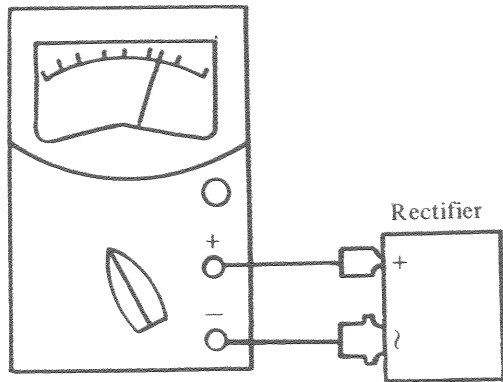

Fig. 7-10-11

For a simple check of the rectifier, wire a circuit as shown in Fig. 7-10-10 using the lamp. If the lamp is lighted by electric current flowing in the correct direction (A in Fig. 7-10-10) and not lighted in the opposite direction (B in Fig. 7-10-10), the rectifier is in good condition.

* Checking with normal connection

Connect the tester's red lead (+) to the rectifier's + terminal, and connect the tester's black lead (-) to the rectifier's ~ terminal. If the tester's pointer will not swing, the rectifier is defective.

* Checking with reversal connection

Connect the tester the other way round. If the pointer will not swing, the rectifier is in good condition. If the pointer swings, the rectifier is faulty.

8. BODY

8-1. FRONT FORK

8-1-1. CONSTRUCTION

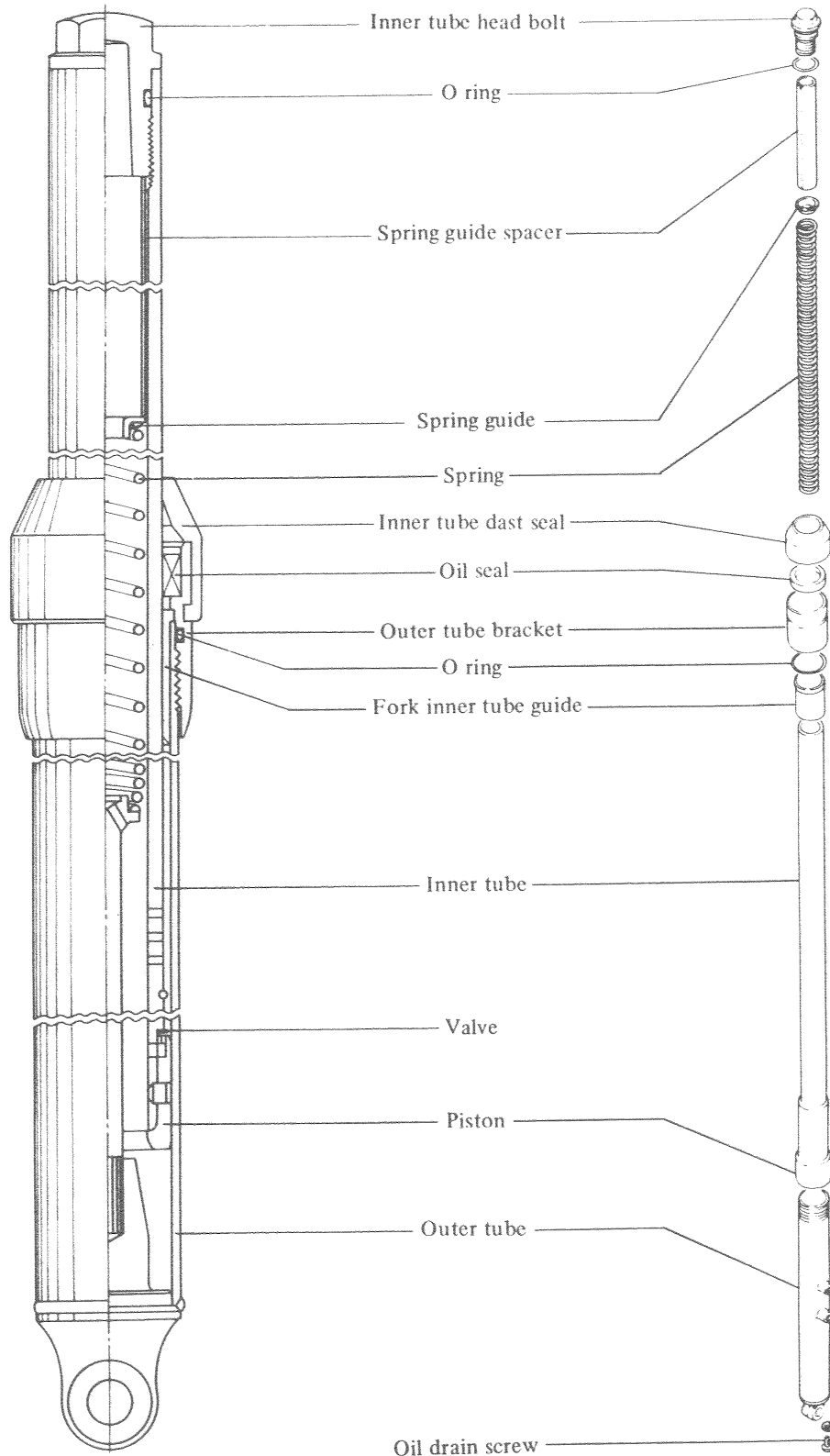

Fig.8-1-1

8-1-2. DISASSEMBLY AND ASSEMBLY

Remove the inner tube head bolt.

Required tool:

○ ○ ○ ○ 22 mm

Tightening torque:

350 ~ 530 kg-cm (25 ~ 38 lb-ft)

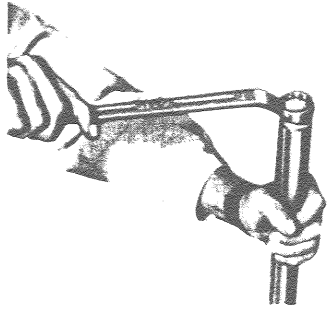

Fig. 8-1-2

Remove the spring guide spacer.

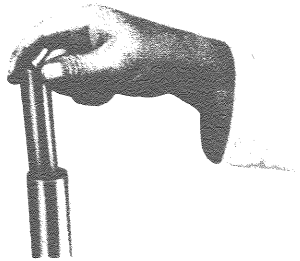

Fig. 8-1-3

Remove the spring guide.



Fig. 8-1-4

Remove the fork spring.

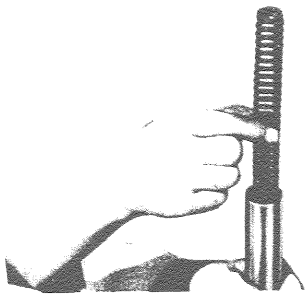

Fig. 8-1-5

Drain front fork oil.

FRONT FORK OIL

CAPACITY : 185 cc in each fork

VISCOSITY : SAE 10W/30

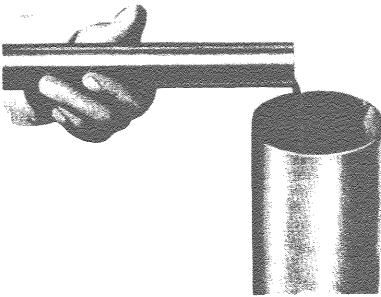

Fig. 8-1-6

Take out the inner tube dust seal.

Required tool:

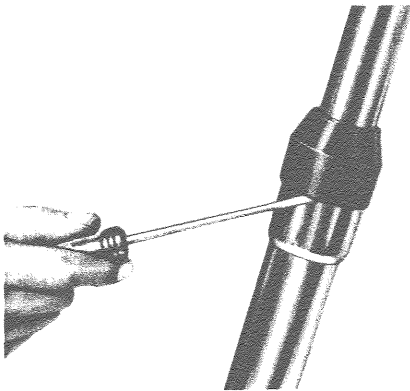

Fig. 8-1-7

Clamp outer tube bracket with vise, removing outer tube nut by using the special tool.

Required tool:

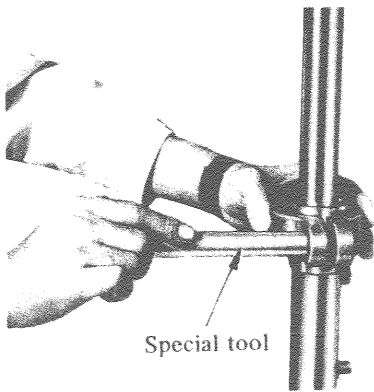
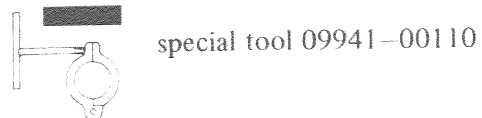

Fig. 8-1-8

Remove the fork inner tube guide.

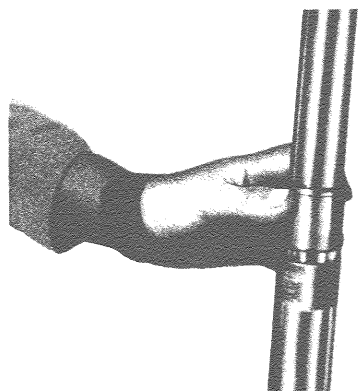

Fig. 8-1-9

* Reassembling the front fork, follow the reverse order of the disassembly.

8-2. REAR SHOCK ABSORBER

8-2-1. CONSTRUCTION

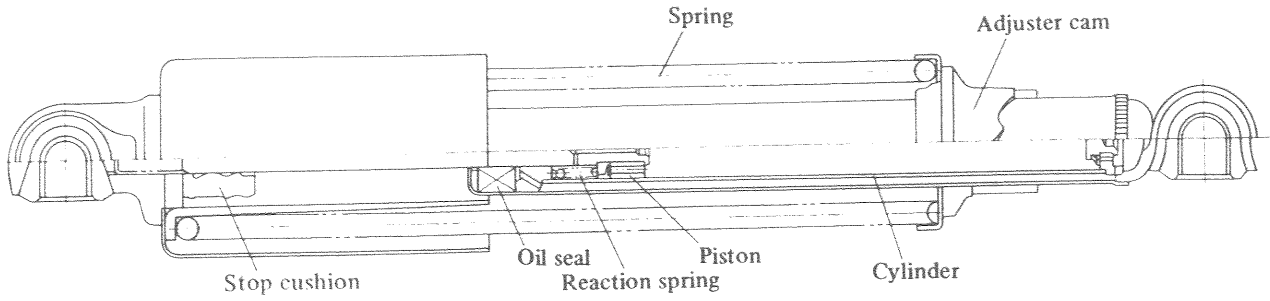

Fig. 8-2-1

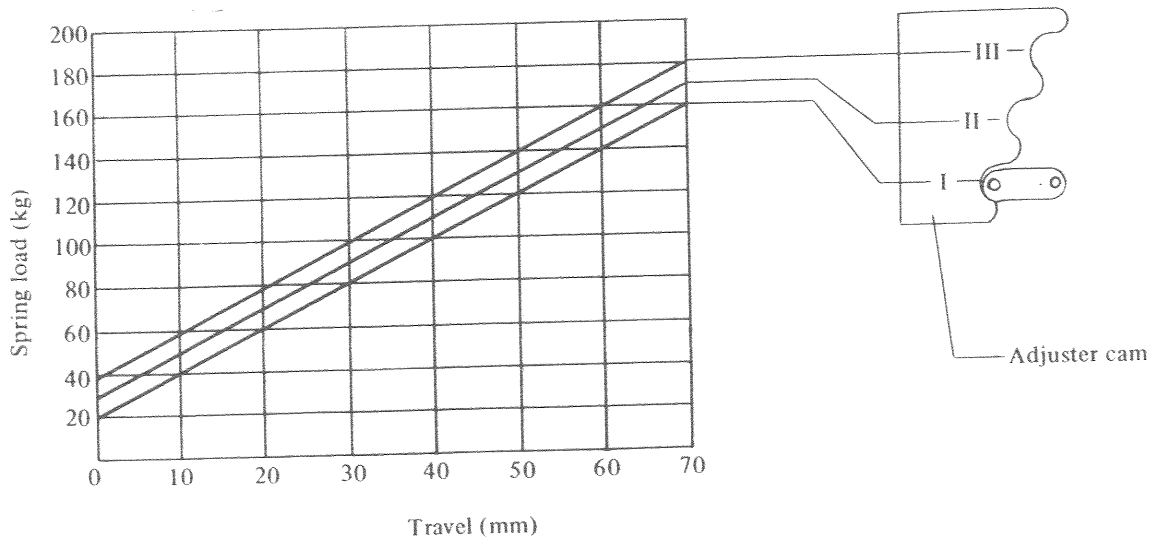

Fig. 8-2-2

Fig. 8-2-2 shows the spring specification and the difference of tension when the adjuster is set in its respective notches.

8-3. BRAKES

8-3-1. FRONT BRAKE

I. ADJUSTMENT

Adjust the brake cable with the cable adjusting nut so that the distance between the brake lever and the throttle grip may be 20 ~ 30 mm (around 1 inch).

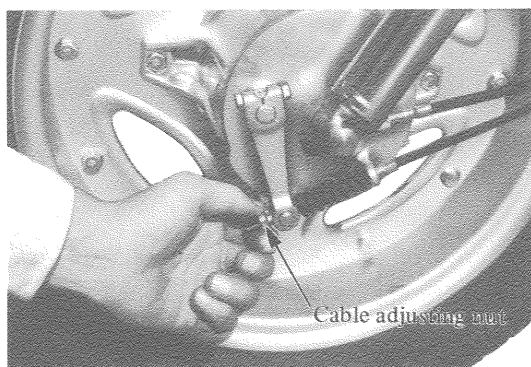

Fig. 8-3-1 Adjusting brake cable

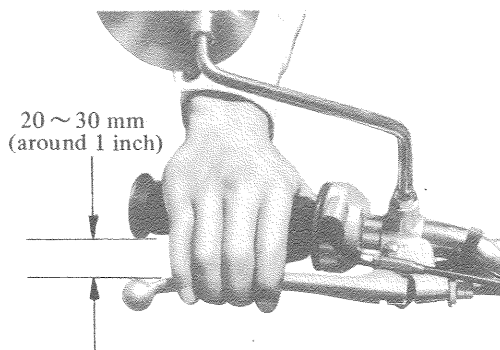

Fig. 8-3-2 Brake lever distance

II. INSPECTION

1) Brake shoe

Check the outside diameter of the brake shoes as shown in Fig. 8-3-3. If the measurement is less than 106 mm (4.17 in), replace both the brake shoes.

2) Brake drum

If the inside diameter of the brake drum exceeds 110.7 mm (4.36 in) due to the wear, replace with new brake drum.

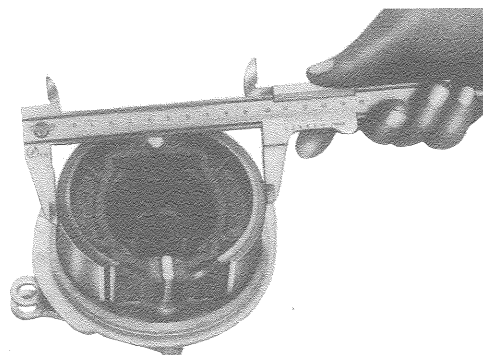

Fig. 8-3-3 Checking wear.

8-3-2. REAR BRAKE

I. ADJUSTMENT

1) Brake pedal position

Set the adjuster shown in Fig. 8-3-4 so that the brake pedal stays at proper position when it is not pressed.

2) Pedal travel

Adjust the travel of the brake pedal with the brake rod adjusting nut as shown in Fig. 8-3-5 so that the proper pedal travel can be obtained.

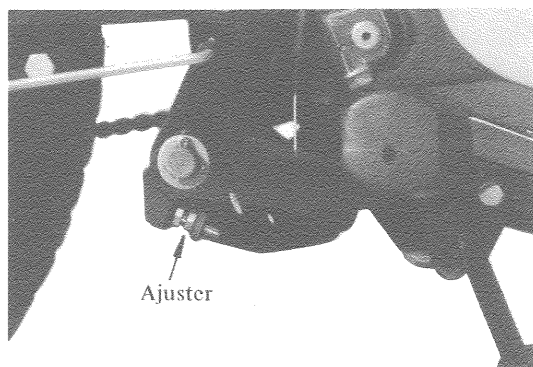

Fig. 8-3-4 Adjusting pedal position

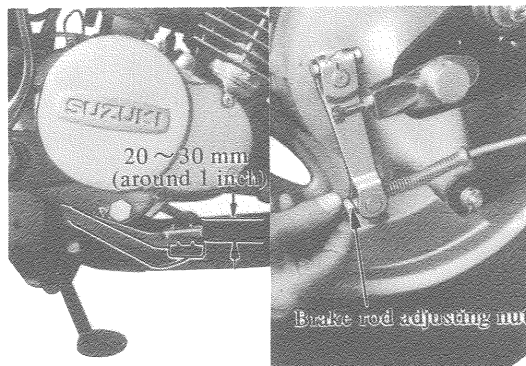

Fig. 8-3-5 Adjusting pedal travel

II. INSPECTION

Check the wear of the brake shoes and brake drum in the same manner as that in the section 8-3-1.

WEAR LIMIT: IN BRAKE SHOE DIAMETER 126 mm (4.96 in)
 IN BRAKE DRUM INSIDE DIAMETER 130.7 mm (5.15 in)

8-4. WHEELS

8-4-1. CONSTRUCTION

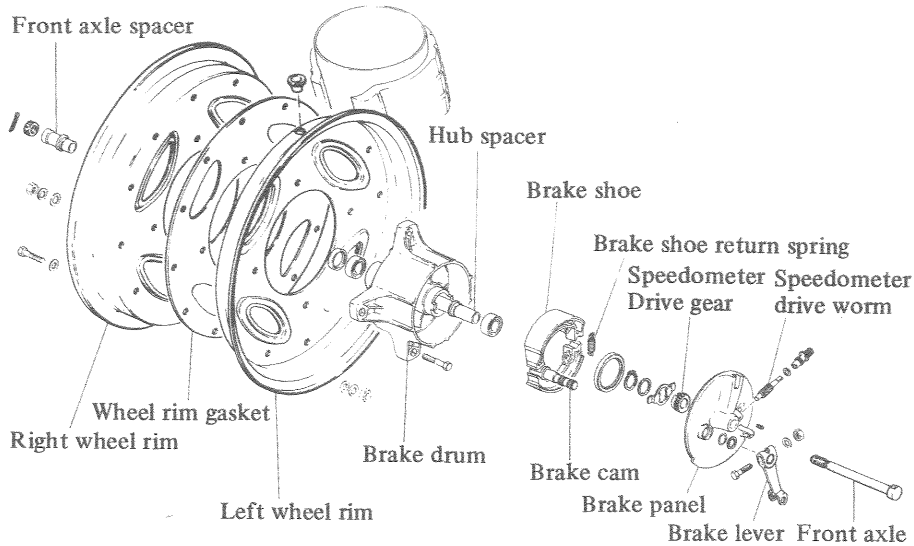

Fig. 8-4-1 Front wheel

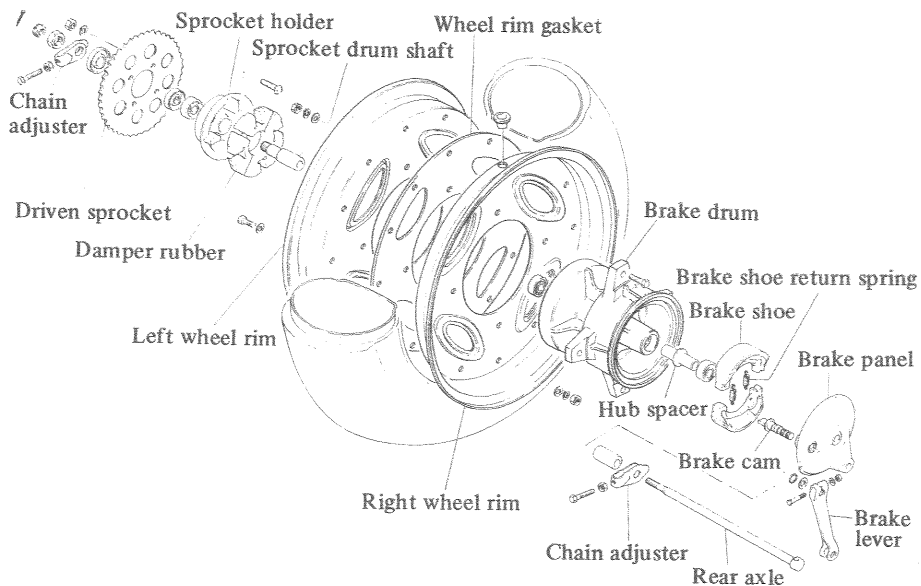

Fig. 8-4-2 Rear wheel

The rim can be separated in half as shown in Fig. 8-4-1 and Fig. 8-4-2 and special designed tire is used on this model.

In order to have the tire driven without a slip of rim, large friction force is required on the mating surface of rim and tire. This force is caused by the inside air pressure which presses the tire edge to the rim. As the tire used on this model is inflated low, the force of the tire to press the rim is also small. In order to get enough friction force without high air pressure, the wheel is specially designed and carefully made.

8-4-2. INSTRUCTION FOR ASSEMBLY OR DISASSEMBLY

Be sure to perform works according to the following instructions.

- 1) Do not use any tool such as tire lever to insert between rim and tire when taking out the tire from rim.
- 2) The tire should only be removed from the rim by separating it in half.
- 3) The edge of tire and rim (where they meet) should be always kept clean in order to have them stuck rigidly by their surfaces.
- 4) When joining the rim, pay attention so as not to pinch the inner tube and do not forget to install the wheel rim gasket between the right and left halves.
- 5) When joining the rim, be sure to tighten the fitting bolts with specified torque.

TIGHTENING TORQUE: 150 ~ 200 kg-cm (11 ~ 14 lb-ft)

- 6) When installing the brake drum to the wheel, be sure to tighten the fitting bolts with specified torque.

TIGHTENING TORQUE: 150 ~ 200 kg-cm (11 ~ 14 lb-ft)

- 7) After assembling the wheel and fitting it to the brake drum, inflate the tire with the pressure of about 2 kg/cm² (28 p.s.i.) so that the tire settles properly in the rim. Then deflate it until the pressure becomes standard value.

8-4-3. REMOVAL AND INSTALLATION

I. FRONT WHEEL

1) REMOVAL

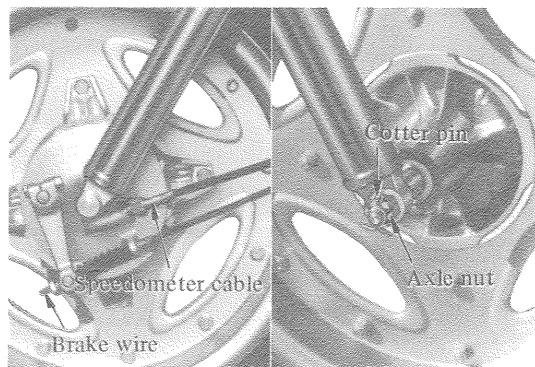

Fig. 8-4-3

Required tool:



○ ——— ○ 27 mm

When removing the front wheel, carry out the job according to the following procedure.

- ① Remove the brake wire.
- ② Disconnect the speedometer cable.
- ③ Loosen the axle nut after removing the cotter pin.
- ④ Remove the axle from left side.

2) INSTALLATION

To install the front wheel, follow the reverse procedure of the removal.

TIGHTENING TORQUE:

Front axle nut 360 ~ 520 kg-cm (26 ~ 38 lb-ft)

II. REAR WHEEL

1) REMOVAL

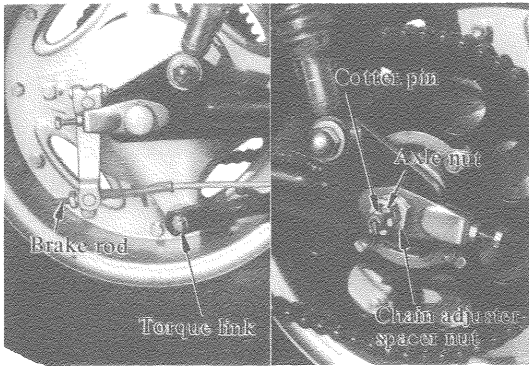
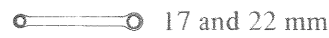

Fig. 8-4-4

Required tool:



When removing the rear wheel, carry out the job according to the following procedure.

- ① Disjoin the chain.
- ② Remove the brake rod at the brake cam lever.
- ③ Disconnect the torque link.
- ④ Loosen the axle nut and chain adjuster spacer nut after removing the cotter pin.
- ⑤ Remove the axle from right side.

2) INSTALLATION

To install the rear wheel, follow the reverse procedure of the removal. When tightening the axle, the drive chain slack should be adjusted at the same time.

TIGHTENING TORQUE:

Chain adjuster spacer nut	450 ~ 600 kg-cm (33 ~ 43 lb-ft)
Axle nut	360 ~ 520 kg-cm (26 ~ 38 lb-ft)
Chain adjuster lock nut	40 ~ 70 kg-cm (2.9 ~ 5.1 lb-ft)
Torque link nut	100 ~ 150 kg-cm (7.2 ~ 11 lb-ft)

When joining the drive chain, be sure the drive chain joint clip is seated in the right direction as shown in Fig. 8-4-5.

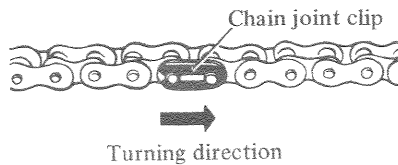

Fig. 8-4-5

* DRIVE CHAIN SLACK

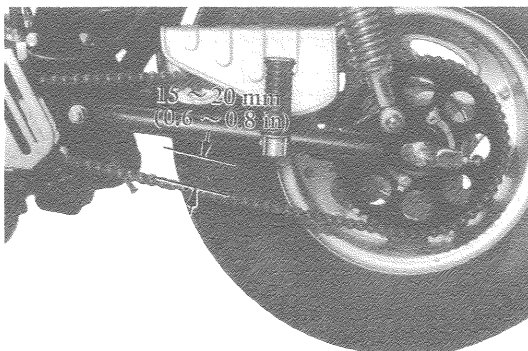

Fig. 8-4-6

Slack of the drive chain should be within 15 ~ 20 mm (0.6 ~ 0.8 in) as shown in Fig. 8-4-6 when the axle is firmly tightened.

8-4-4. TIRES

I. WEAR LIMIT

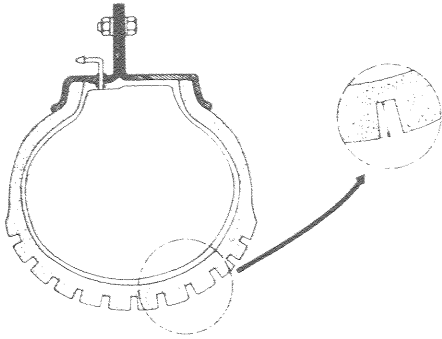

Fig. 8-4-7

To ensure the braking effect and the riding stability, the tire should keep enough depth in the grooves shaped on the tread surface. When the depth of the tire shown in Fig. 8-4-7 reaches the wear limit given below, replace with new tire.

WEAR LIMIT IN DEPTH: 1.6 mm (0.06 in)

TIRE USED ON THIS MODEL:

Front . . . BRIDGESTONE 5.4-14, 4PR

Rear . . . BRIDGESTONE 6.7-12, 4PR

II. RECOMMENDED TIRE PRESSURE

Since tire pressure affects the durability, comfortable ride and safety in driving to a great extent, it is necessary that the pressure be always kept properly. The following list shows the recommended tire pressure for this model.

	FRONT				REAR			
	SOLO RIDING		DUAL RIDING		SOLO RIDING		DUAL RIDING	
	kg/cm ²	p.s.i.	kg/cm ²	p.s.i.	kg/cm ²	p.s.i.	kg/cm ²	p.s.i.
ON ROAD	0.8	11	0.8	11	0.8	11	1.0	14
ON SAND	0.6	9	0.6	9	0.6	9	0.8	11

In order to have the tire properly settled in the rim, first inflate it with the pressure of 2 kg/cm² (28 p.s.i.) and then adjust the pressure by deflating it.

8-5. DRIVE CHAIN

8-5-1. MAINTENANCE

The drive chain must be checked and serviced at the time of every 3,000 km (2,000 mi) and lubrication is indispensable at this time of the service. If the machine is used in extremely dusty or sandy condition, it is recommended to wash and lubricate every time.

8-5-2. INSPECTION

Check the drive chain for any of the following conditions. The sprockets should also be checked at the same time since the wear of the sprockets are subsequent to that of the chain.

DRIVE CHAIN

- * Damaged rollers
- * Loose pins
- * Dry or rusted links
- * Kinked or bent links
- * Excessive wear
- * Improper adjustment

SPROCKETS

- * Excessive wear
- * Broken or damaged teeth
- * Loosen sprocket nuts

8-6. BODY ELECTRICAL

8-6-1. SWITCHES

This section explains the inside wiring of the switches. When checking their functions, connect a circuit tester to the switches referring to the inside wiring given below.

I. IGNITION SWITCH

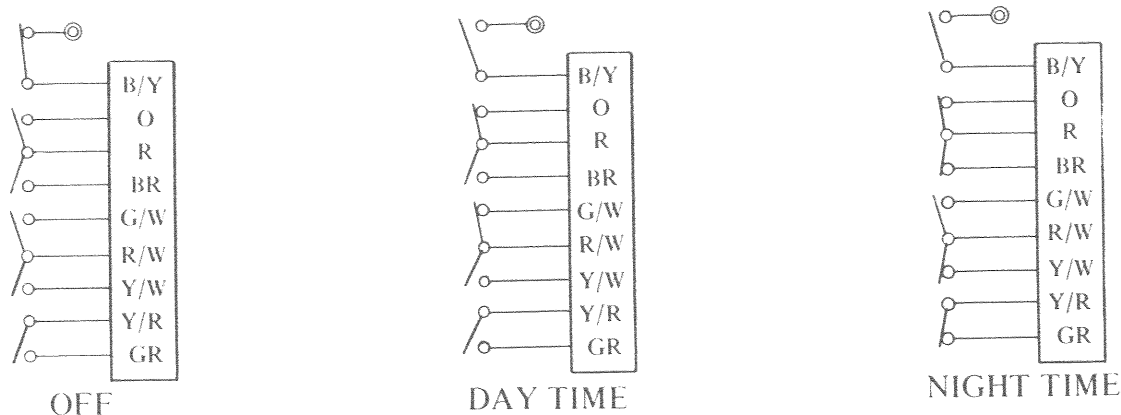

Fig. 8-6-1

B/Y : Black with Yellow tracer

O : Orange

R : Red

BR : Brown

G/W : Green with White tracer

R/W : Red with White tracer

Y/W : Yellow with White tracer

Y/R : Yellow with White tracer

GR : Gray

II. HANDLE LEFT SWITCH BOX

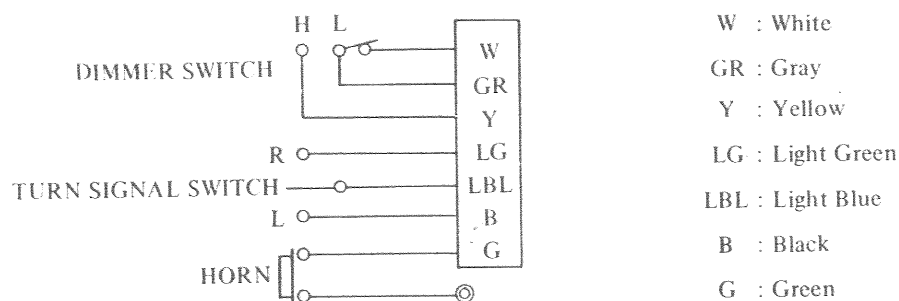

Fig. 8-6-2

W : White

GR : Gray

Y : Yellow

LG : Light Green

LBL : Light Blue

B : Black

G : Green

8-6-2. TURN SIGNAL RELAY

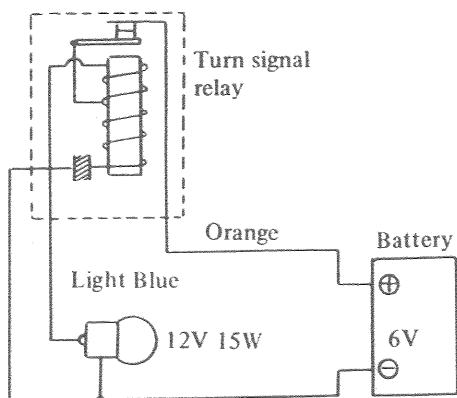

Fig. 8-6-3

If the turn signal relay is to be checked separately from the original wiring, connect a bulb of 6 V 15 W as shown in Fig. 8-6-3. If the turn signal relay functions properly, the bulb must blink continuously with constant frequency.

8-6-3. BATTERY

The battery used on this model is either of YUASA or FURUKAWA make. Both of them are of same type 6N4 - 2A, and there is interchangeability between them.

I. INITIAL CHARGE

The battery is of dry-charged type unlike that of a large capacity battery, however, it necessitates the initial charging with the specified rate before the battery is put in use since the plates may be oxidized to a certain extent during the storage.

* INITIAL CHARGING RATE: 0.4A 10 ~ 12 Hours

* SPECIFIC GRAVITY OF ELECTROLYTE: 1.280 at 20°C (68°F)

II. RECHARGE

To check the battery condition in capacity, measure the specific gravity of electrolyte by means of hydrometer and refer to the following list.

SPECIFIC GRAVITY at 20°C (68°F)	CONDITION	NECESSARY MEASURE
1.250 ~ 1.280	OK	
1.220 ~ 1.250	Under charged	Recharge
Below 1.220	Run down	Replace or recharge

Recharging rate: 0.4 A 10 ~ 12 Hours

NOTE : When recharging the battery, be sure to remove it from the motorcycle in order to prevent the rectifier from being damaged due to excessive voltage given by any chance.

9. SPECIFICATIONS FOR INSPECTION AND REPAIR

9-1. ENGINE

Part	Item	Standard	Limit	Operation	Remarks
Cylinder head	Warp on the joining surface	below 0.03 mm (0.001 in)		Rectify	Put emery paper on a flat surface plate and grind the head on the paper by sliding it evenly.
Cylinder	Wear		0.1 mm (0.004 in)	Rebore	Measurement is the difference between largest and smallest diameter of the bore
	Cylinder-piston clearance	0.050 mm (0.002 in)	0.155 mm (0.0061 in)		
Piston ring	Open end	0.15–0.35 mm (0.006–0.014 in)	1.0 mm (0.004 in)	Replace	Measure the gap with thickness gauge when the ring is inserted into the lower part of cylinder.
Crank-shaft	Con-rod small end shake		3 mm (0.12 in)	Replace	Check the shake at TDC with dial gauge.
	Radial run out	below 0.05 mm (0.002 in)		Rectify or replace	Check run out at left and right ends with dial gauge when both journal positions are held.
Clutch drive plate	Thickness	3 mm (0.12 in)	2.8 mm (0.11 in)	Replace	
	Warp	below 0.4 mm (16/1,000 in)		Replace	
Clutch driven plate	Warp	below 0.1 mm (0.004 in)		Replace	

9-2. ELECTRICAL EQUIPMENT

Part	Item	Standard	Limit	Operation	Remarks
Flywheel magneto	Resistance, primary coil	2.0 Ω		Replace	Measure between black/yellow colored wire and the ground with inserting a insulation material to the points.
	Resistance, lighting coil	0.6 Ω		Replace	Measure between yellow/red colored wire and ground.
	Resistance, charging coil	0.7 Ω		Replace	Measure between yellow/white colored wire and ground.
	Condenser capacity	0.18 μ F		Replace	
	Lighting coil output	over 6V/2,500rpm below 9V/8,000rpm		Replace	With the ignition switch in night time position
	Charging capacity in day time	starts to charge at 2,700rpm below 3.2A/8,000rpm		Replace	With fully charged battery
	Charging capacity in night time	over 0.5A/2,000rpm below 3.2A/8,000rpm		Replace	With fully charged battery
	Ignition performance	over 7 mm (0.276 in)		Replace	The testing gap is to be connected in series with spark plug.
	Contact point gap	0.3 ~ 0.4 mm (0.012 ~ 0.016 in)		Adjust	
Ignition coil	Resistance, primary coil	2.5 Ω		Replace	
	Resistance secondary coil	8.3 Ω		Replace	
Rectifier	Conductivity	Not in reverse direction		Replace	
Resistor	Resistance	3.6 ~ 4.4 Ω		Replace	

9-3. BODY

Part	Item	Standard	Limit	Operation	Remarks
Front fork	Damper oil	SAE 10W/30 185 cc in each fork			
Brake shoe	Wear		Front: 106 mm (4.17 in) Rear: 126 mm (4.96 in)	Replace	Measure the diameter when the shoes are installed on the pannel.
Brake drum	Wear	Front: 110 mm (4.33 in) Rear: 130 mm (5.12 in)	Front: 110.7 mm (4.36 in) Rear: 130.7 in (5.15 in)	Replace	
Drive chain	Slack	15-20 mm (0.6-0.8 in)		Adjust	
Tire	Wear in Depth		Front: 1.6 mm (0.06 in)	Replace	
			Rear: 1.6 mm (0.06 in)		

10. TIGHTENING TORQUE

	Part	Tightening torque	
		kg-cm	lb-ft
1.	Front axle nut	360 ~ 520	26 ~ 38
2.	Front brake cam lever bolt	50 ~ 80	3.6 ~ 5.8
3.	Front fork upper inner tube bolts	200 ~ 300	14 ~ 22
4.	Front fork lower inner tube bolts	250 ~ 350	18 ~ 25
5.	Steering stem bolt	350 ~ 550	25 ~ 40
6.	Handlebar clamp bolts	120 ~ 200	8.7 ~ 14
7.	Swinging arm pivot shaft nut	300 ~ 450	22 ~ 33
8.	Footrest bolts	150 ~ 250	11 ~ 18
9.	Rear axle nut	360 ~ 520	26 ~ 38
10.	Chain adjuster spacer nut	450 ~ 600	33 ~ 43
11.	Rear brake cam lever bolt	50 ~ 80	3.6 ~ 5.8
12.	Rear brake torque link nuts	100 ~ 150	7.2 ~ 11
13.	Rear shock absorber nuts	200 ~ 300	14 ~ 22
14.	Rim nuts	150 ~ 200	11 ~ 14
15.	Wheel fitting nuts	150 ~ 200	11 ~ 14

Tightening torque for general bolts

Bolt diameter (mm)	Tightening torque			
	Usual bolt		"S" marked bolt	
	kg-cm	lb-ft	kg-cm	lb-ft
5	20 - 40	1.5 - 2.9	30 - 60	2.2 - 4.4
6	40 - 70	2.9 - 5.1	60 - 100	4.4 - 7.3
8	90 - 140	6.6 - 10	130 - 230	9.5 - 17
10	180 - 280	13 - 20	250 - 400	18 - 29

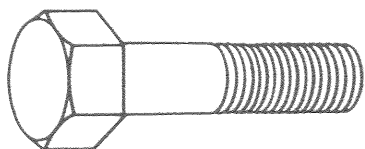

USUAL BOLT

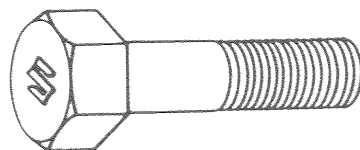

"S" MARKED BOLT

11. IMPORTANT FUNCTIONAL PARTS

For safety driving of motorcycle, it is highly requested to check up the important items in accordance with following check list taking opportunity of periodical inspection.

Check list of important functional parts for safety driving.

	Item	Check for
Fuel system	Fuel hose Fuel tank	Fuel leakage
Suspension system	Front fork ass'y	Crack, Faulty welding of bracket
	Front fork comp. Front fork upper bracket	Crack, Faulty welding
	Front axle Rear axle	Crack
	Rear swinging arm	Crack, Faulty welding
Steering	Handlebar Handlebar upper clamp Handlebar lower clamp	Crack
Braking system	Front hub drum Rear hub drum Front hub panel Rear hub panel	Crack
	Rear torque link	Crack
	Front brake shoe Rear brake shoe	Crack, Peeling off of lining
	Front brake cam shaft Rear brake cam shaft	Crack, Deformation of serration
	Rear brake rod	Crack
	Brake pedal	Crack, Faulty welding
	Brake lever	Crack
	Front brake cable ass'y	Detachment of cable end
Frame	Frame	Crack, Faulty welding

PERIODICAL INSPECTION LIST

The chart below indicates time when inspections, adjustments and maintenance are required based on the distance the motorcycle runs, that is first 1,000 km (750 mi), and every 1,000 km (2,000 mi), 6,000 km (4,000 mi) and 12,000 km (8,000 mi) thereafter. According to the chart, advise users to make the motorcycle checked and serviced at your shop. See the appropriate section for instructions on making the inspection.

Service	Distance (km)	1,000 km	Every 3,000 km	Every 6,000 km	Every 12,000 km
	Distance (mi)	750 mi	Every 2,000 mi	Every 4,000 mi	Every 8,000 mi
Oil pump		Check operation, adjust control lever adjusting marks	Check operation, adjust control lever adjusting marks		
Spark plug		Clean	Clean and adjust gap	Replace	
Gearbox oil		Change	Change		
Throttle and brake cables		Adjust play	Adjust play	Lubricate	
Carburetor		Adjust with throttle valve screw and pilot air screw	Adjust with throttle valve screw and pilot air screw		Overhaul and clean
Magneto		Retighten magneto nut Check contact point gap and ignition timing	Check contact point gap and ignition timing. Lubricate contact breaker cam oil felt		
Cylinder head and Cylinder		Retighten cylinder and cylinder head nuts	Retighten cylinder and cylinder head nuts	Remove carbon	
Battery		Check and service electrolyte	Check and service electrolyte		
Fuel tank		Clean fuel strainer		Clean fuel strainer	
Drive chain		Adjust	Adjust and lubricate	Wash	
Brakes		Adjust play	Adjust play		
Air cleaner			Clean		Replace
Throttle grip				Put grease in throttle grip	
Exhaust pipe and Muffler		Retighten exhaust pipe flange fitting screw	Retighten exhaust pipe flange fitting screw	Remove carbon	
Steering stem		Check play Retighten stem nut		Check play Retighten stem nut	
Bolts and Nuts		Retighten		Retighten	

EXPLODED VIEW OF ENGINE

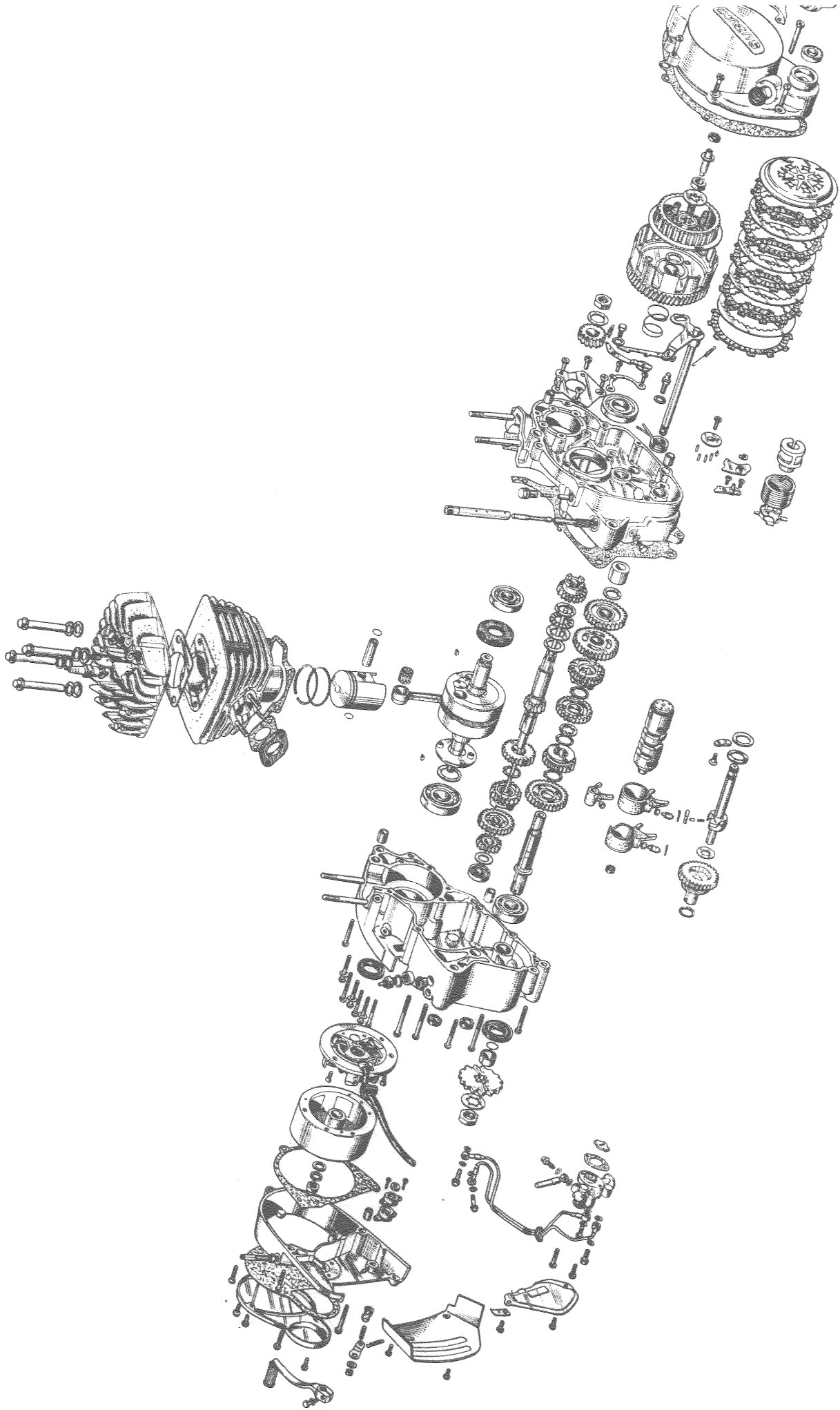

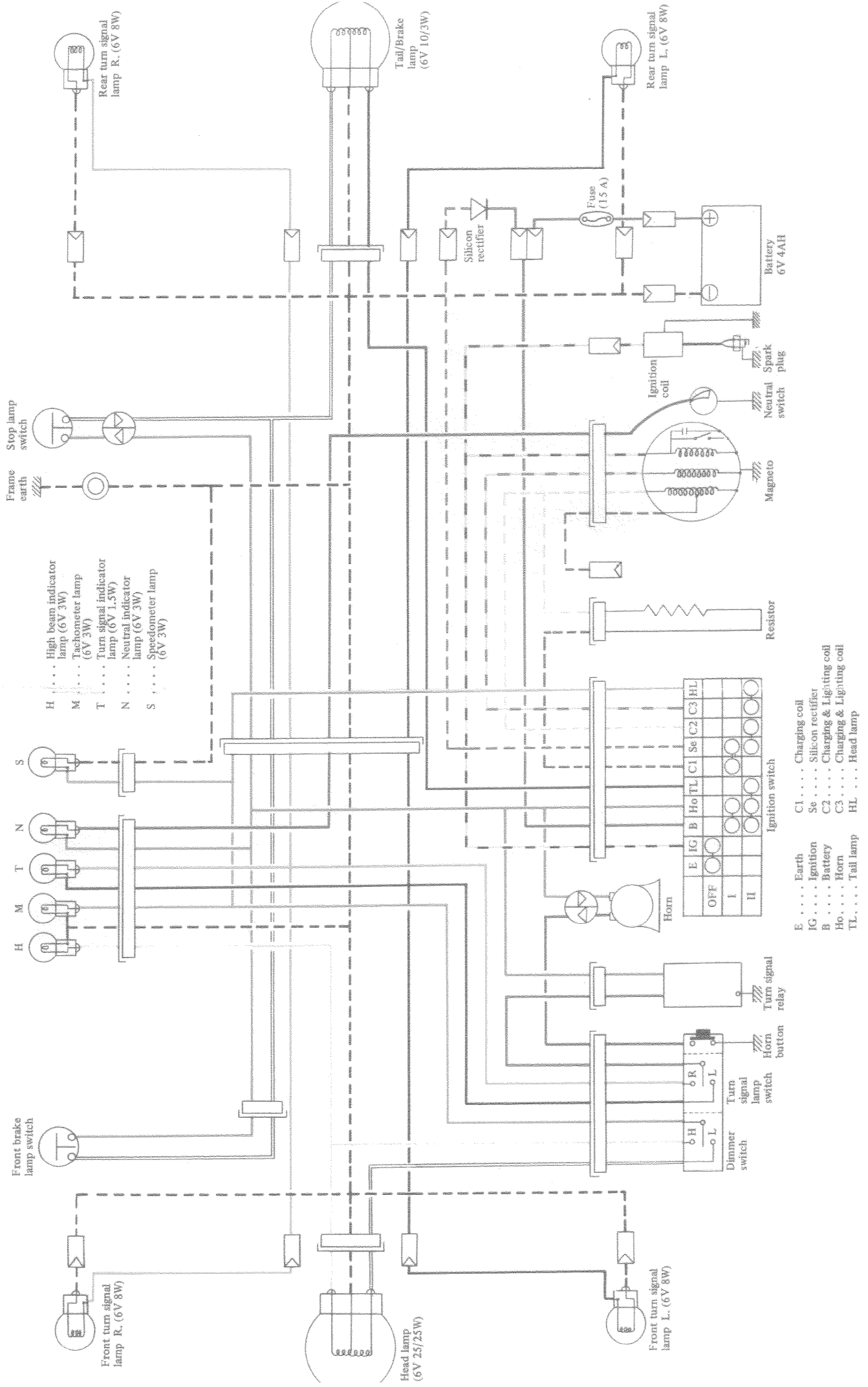

- H High beam indicator lamp (6V 3W)
- M Tachometer lamp (6V 3W)
- T Turn signal indicator lamp (6V 1.5W)
- N Neutral indicator lamp (6V 3W)
- S Speedometer lamp (6V 3W)

- E Earth
- IG Ignition
- B Battery
- Ho Horn
- TL Tail lamp
- C1 Charging coil
- Se Silicon rectifier
- C2 Charging & Lighting coil
- C3 Charging & Lighting coil
- HL Head lamp